



Mono FSTN Display Module

Product Specification
Part No. YMS-12864- 20ABFFDGL
128 x 64 FSTN Display

For more information, please visit www.andersdx.com
or email info@andersdx.com

Version 1.0

SPECIFICATIONS FOR LIQUID CRYSTAL DISPLAY MODULE

MODEL NO.: YMS12864-20ABFFDGL

DATE: MAY.6.2010

Approved	Checked	Department

CUSTOMER:

MODEL NO.:

DATE:

Approved	Checked	Department

DATE MAY.6.2010			TECHNICAL SPECIFICATION
LCM		YMS12864-20ABFFDGL	Page 1 of 17

LIST

I . General Specifications -----(3-6)

II . The Characteristics and Reliability Test -----(7-8)

III. The Equipment and LCD Measuring Method-----(9-10)

IV. Standard Specifications for Product Quality -----(11-12)

V. Attached Drawing -----(13)

VI. Packing----- (14-15)

VII. Precautions For Use -----(16-17)

DATE MAY.6.2010			TECHNICAL SPECIFICATION
LCM		YMS12864-20ABFFDGL	Page 2 of 17

I .General Specifications

1.The Features :

- (1). Low power consumption 3.0V
- (2).Drive method: 1/65 duty,1/9bias
- (3). Viewing direction: 6:00
- (4). Operating tempration: 0~50°C
- (5). Storage tempration: -20~70°C
- (6). Display type: FSTN mode, Transflective,Positive type display

2.Mechanical Data:

- (1) Module Size ----- 70.2 w * 41.6 h mm
- (2) Viewing Area ----- 59.0w *30.5 h mm
- (3) Dot Size ----- 0.39 w * 0.39 h mm
- (4) Dot Quality----- 128 * 64DOTS
- (5) Outline Dimensions----- See Attached Drawing

DATE MAY.6.2010			TECHNICAL SPECIFICATION
LCM		YMS12864-20ABFFDGL	Page 3 of 17

3. Absolute Maximum Ratings

In accordance with the Absolute Maximum Rating System; please refer to notes 1 and 2.

Parameter	Symbol	Conditions	Unit
Digital Power Supply Voltage	VDD1	-0.3 ~ 3.6	V
Analog Power supply voltage	VDD2, VDD3	-0.3 ~ 3.6	V
LCD Power supply voltage	V0-XV0	-0.3 ~ 16	V
LCD Power supply voltage	VG	-0.3 ~ 3.6	V
LCD Power supply voltage	VM	-0.3 ~ VDD2	V
Input Voltage	Vi	-0.3 ~ VDD1+0.3	V

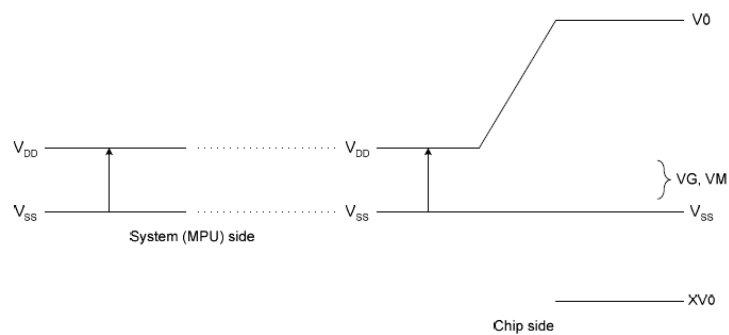

Notes

1. Stresses above those listed under Limiting Values may cause permanent damage to the device.
2. Parameters are valid over operating temperature range unless otherwise specified. All voltages are with respect to VSS unless otherwise noted.
3. Insure the voltage levels of V0, VDD2, VG, VM, VSS and XV0 always match the correct relation:
 $V0 \geq VDD2 > VG > VM > VSS \geq XV0$

DATE MAY.6.2010			TECHNICAL SPECIFICATION
LCM		YMS12864-20ABFFDGL	Page 4 of 17

4.Pin Connections:

Pin No.	Symbol	Function
1-5	NC	No connection
6	VG	LCD driving voltage for segment circuits
7-8	NC	No connection
9	XV0	LCD driving voltage for common circuits at positive frame
10	V0	LCD driving voltage for common circuits at negative frame
11-12	NC	No connection
13	VSS	Ground
14	VDD	Power supply
15	SDA	Serial data input
16	SCL	Serial clock input
17	A0	Data or command
18	RSTB	Hardware reset input pin
19	CSB	Chip select input pin
20	NC	No connection

DATE MAY.6.2010			TECHNICAL SPECIFICATION
LCM		YMS12864-20ABFFDGL	Page 5 of 17

5. AC CHARACTERISTICS

System Bus Timing for 4-Line Serial Interface

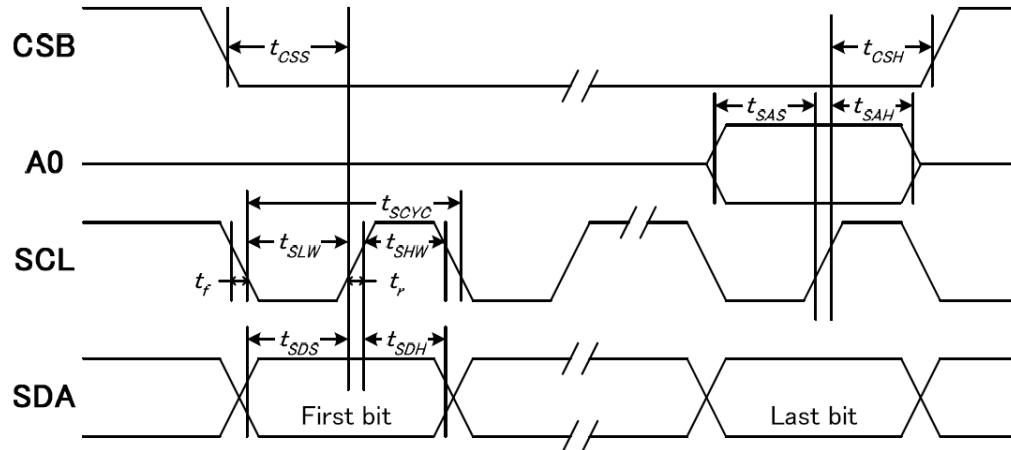

(VDD1 = 3.3V, Ta = 25°C)

Item	Signal	Symbol	Condition	Min.	Max.	Unit
Serial clock period	SCLK	tSCYC		50	—	ns
SCLK "H" pulse width		tSHW		25	—	
SCLK "L" pulse width		tSLW		25	—	
Address setup time	A0	tSAS		20	—	
Address hold time		tSAH		10	—	
Data setup time	SDA	tSDS		20	—	
Data hold time		tSDH		10	—	
CSB-SCLK time	CSB	tCSS		20	—	
CSB-SCLK time		tCSH		40	—	

*1 The input signal rise and fall time (tr, tf) are specified at 15 ns or less.

*2 All timing is specified using 20% and 80% of VDD1 as the standard.

DATE MAY.6.2010			TECHNICAL SPECIFICATION
LCM		YMS12864-20ABFFDGL	Page 6 of 17

II .The Characteristics and Reliability Test

1.Electro-Optic Characteristics

Condition:TEMP=(23±3)°C

NO	Item	Symbol	Min.	Typ.	Max.	Unit	Condition
1	Supply Voltage(Logic)	Vdd-Vss		3.0		V	
2	LCD Operating Voltage	V ₀ -Vss		8.5		V	0°C
				8.3		V	25°C
				8.1		V	50°C
3	Response Time	Ton		89		ms	
		Toff		305		ms	
4	Contrast	CR	2				
5	Viewing Angel	12H	θ 1	60		Deg.	(CR≥2.0)
		6H	θ 2	70			
		3H	θ 3	65			
		9H	θ 4	65			

2. Characteristics of backlight (LED unit)

Color: WHITE

Item	Symbol	MIN	TYP.	MAX	UNIT	CONDITIONS
Forward Voltage	V _f	4.3	4.5	4.7	V	I _f =30mA
Forward Current	I _f		30	40	mA	
power dissipation	P _d		0.135		W	I _f =30mA
Reverse Voltage	V _r		5		V	
Reverse Current	I _r		0.2		mA	
Luminous Intensity	L _v	40	50		cd/m ²	I _f =30mA
Luminous Uniformity	ΔL _v	70			%	I _f =30mA
Chromaticity coordinate	X	0.270	--	0.31		I _f =15 mA Each Chip
	Y	0.270	--	0.31		

Operating Temperature Range	T _{opr}	-20°C TO +65°C
Storage Temperature Range	T _{sty}	-30°C TO +70°C

WARNING:

A BACKLIGHT IS A KIND OF CURRENT DEVICE,IT MUST CONNECT A RESISTANCE FOR LIMITING CURRENT ,OR IT WILL BE DAMAGED.

DATE MAY.6.2010			TECHNICAL SPECIFICATION
LCM		YMS12864-20ABFFDGL	Page 7 of 17

3. Reliability Test

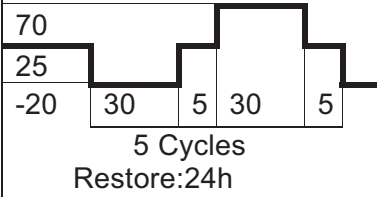
No	Items	Test Condition	Equipment	Test Result
1	High Temp Storage	Temp: $70 \pm 2^{\circ}\text{C}$ Time: 96h Restore: 24h	Tenny	Passed
2	Low Temp Storage	Temp: $-20 \pm 3^{\circ}\text{C}$ Time: 96h Restore: 24h	Tenny	Passed
3	High Temp Static drive	Temp: $50 \pm 2^{\circ}\text{C}$ Vop: 3.0V Time: 24h Restore: 24h	Tenny	Passed
4	Low Temp Static drive	Temp: $0 \pm 3^{\circ}\text{C}$ Vop: 3.0V Time: 24h Restore: 24h	Tenny	Passed
5	High Temp High Hum Storage	Temp: $40 \pm 2^{\circ}\text{C}$ Hum: 95%Rh Time: 96h Restore: 24h	Tenny	Passed
6	Thermal Shock	Temp: ($^{\circ}\text{C}$)  5 Cycles Restore: 24h	Tenny	Passed
7	ESD	Contact charge: 8KV Discontact charge: 8KV	Tenny	Passed

DATE MAY.6.2010

TECHNICAL SPECIFICATION

LCM

YMS12864-20ABFFDGL

Page 8 of 17

III. The Equipment and LCD Measuring Method

1. Equipment

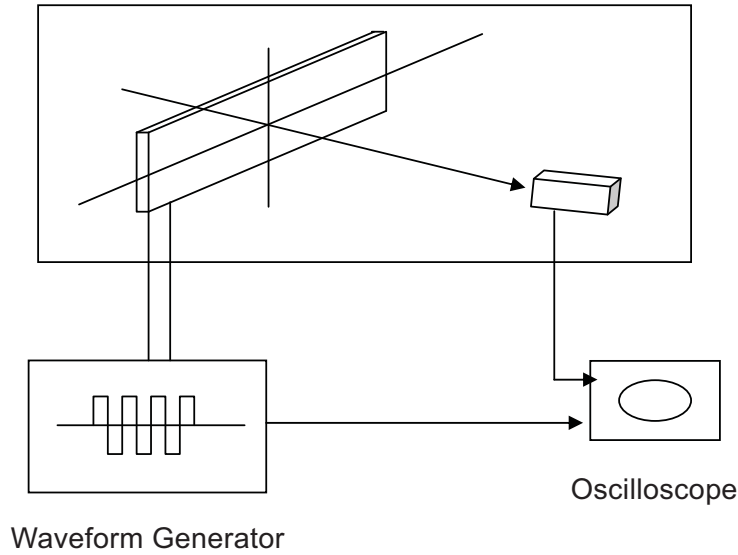

2. Definition

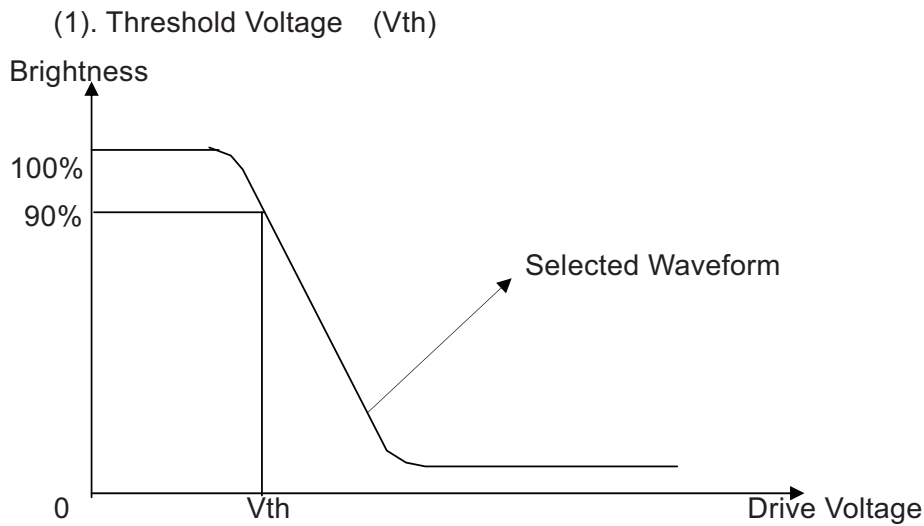

DATE MAY.6.2010			TECHNICAL SPECIFICATION
LCM		YMS12864-20ABFFDGL	Page 9 of 17

(2). Response Time

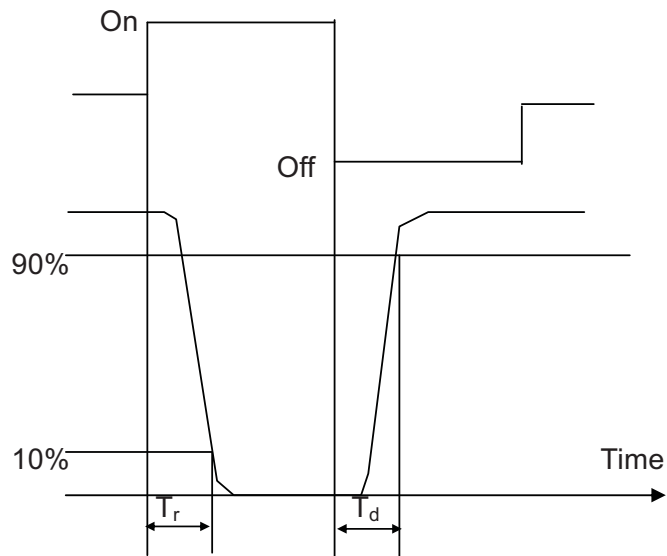

(3). Viewing Angle:

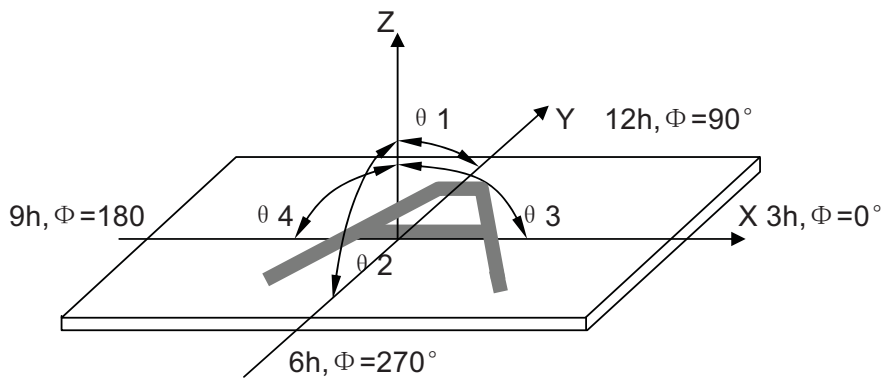

(4). Contrast Ratio (Positive)

$$CR = \frac{\text{Brightness of non-selected wave-form}}{\text{Brightness of selected wave-form}}$$

3. Reliability Test:

Equipment : TENNY

DATE MAY.6.2010			TECHNICAL SPECIFICATION
LCM		YMS12864-20ABFFDGL	Page 10 of 17

IV. Standard Specifications for Product Quality

1. MTBF

More than 87,600 hours.

2. Manner of Test::

(1) The Test Must Be Under 40w Fluorescent Light, And The Distance Of View Must Be At 30cm.

(2) The Test Direction Is Based On Around 15° - 45° Of Vertical Line.

3. Definition Of Defects

(1) Major Defects

A: Non-Display

B: Segment Missing

C: Over Current

D: Segment Short

E: Sealant Dishardexn

F: Wrong Polarizer Direction

(2) Minor Defects: The Others.

4. Major Defects Should Be In AQL 0.25, and The Minor In AQL 1.00

DATE MAY.6.2010			TECHNICAL SPECIFICATION
LCM		YMS12864-20ABFFDGL	Page 11 of 17

5. Inspection Item and Standards

Item	The Standard Of Quality Inspection	Checking Manner	Quality Ratio
Frame	Smooth and even surface, no crack, no scratch, no rusty, and not be wrenched out of shape. the range between convex and concave is: $d \leq 0.35\text{mm}$, and the frame must be connected to the ground.	Checking With Eyes And Using Vernier Caliper, Multimeter	100%
LCD	The major defects would be reject. no scratch and no dusty on the LCD glass surface. $d \leq 0.15\text{mm}$ $n \leq 2$ diameter of bubble $d \leq 0.5$ $n \leq 2$ damaged size of polarizer.	Check It When Displaying	100%
The Relative Position of LCD and Frame	The sealant mouth of the LCD must be at the same side with the frame's.	Checking With Eyes	100%
The Relative Position of PCB Panel and Frame	The frame installing direction must be correct. the twisted angle of the pin is from 45° to 60° , the pin is vertical to PCB panel and it must be in the middle position of the installing holes.	Checking With Eyes	100%
LED	1. The led would be White 2. The led would be uniform.	Checking With Eyes	100%
Function Test	1. The major defects must be reject. 2. Background changes evenly and no disorderly displaying phenomenon. 3. Display no shortage.	Check It When Displaying	100%

Note: D ~ Diameter N ~ Quantity Unit: mm

DATE MAY.6.2010			TECHNICAL SPECIFICATION
LCM		YMS12864-20ABFFDGL	Page 12 of 17

V.Attached Drawing

PAGE:	DATE:	CUSTOMER'S APPROVED:	
NO.	DESCRIPTION	DATE	Unit: mm
1	No.YMS12864-20ABFFDGL	Ver.1	Dru
2			Chk
3			Apu
4			

1	Operating Voltage:	3.0V	
2	Drive method:	1/65Duty,1/9Bias	
3	Viewing Direction:	6:00	
4	Operating Temp:	0°C~50°C	
5	Storage Temp:	-20°C~70°C	
6	Display type:	FSTN,Positive,T/H	
7	Unspecified tolerance:	±0.2	
8	LCD controller/driver:	ST7567,Serial	
9	Backlight:	LED/W	
10	Customer No.:		
11	Dimensions with mark** are important		
12	RoHS compliant		

PIN	SYMBOL	PIN	SYMBOL	PIN	SYMBOL	PIN	SYMBOL	PIN	SYMBOL
1	NC	11	NC	1	NC	11	NC	1	NC
2	NC	12	NC	2	NC	12	NC	2	NC
3	NC	13	VSS	3	NC	13	VSS	3	NC
4	NC	14	VDD	4	NC	14	VDD	4	NC
5	NC	15	SDA	5	NC	15	SDA	5	NC
6	VG	16	SCL	6	VG	16	SCL	6	VG
7	NC	17	A0	7	NC	17	A0	7	NC
8	NC	18	RSTB	8	NC	18	RSTB	8	NC
9	XV0	19	CSB	9	XV0	19	CSB	9	XV0
10	V0	20	NC	10	V0	20	NC	10	V0

DATE MAY.6.2010			TECHNICAL SPECIFICATION
LCM	YMS12864-20ABFFDGL	Page 13 of 17	

VI.Packing

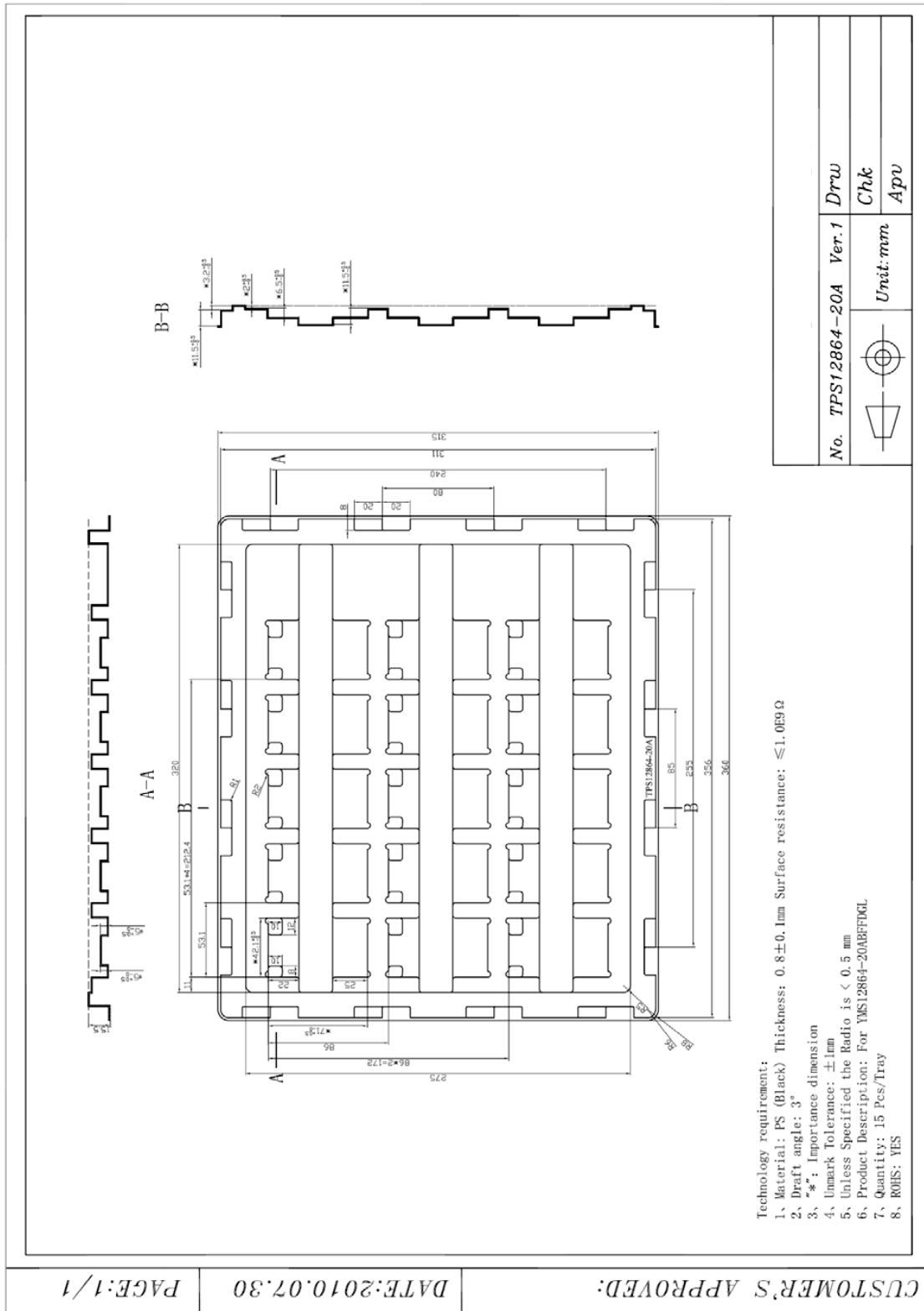

DATE MAY.6.2010

LCM

YMS12864-20ABFFDGL

TECHNICAL SPECIFICATION

Page 14 of 17

<i>CUSTOMER'S APPROVED:</i>	<i>DATE: 2010.07.30</i>	<i>PAGE: 1/1</i>
-----------------------------	-------------------------	------------------

PRODUCT PART NO.: YMS12864-20ABFFDGL

PACKING TYPE: BY PS TRAY(TPS12864-20A)

PACKLING ORDER:

1) Putting 15 pcs Modules on each PS tray.

2) Putting 6 pcs PS trays together with EPE paper on the top of PS tray.

3) Assembling the boards and the tray together with adhesive tape

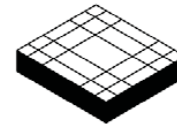
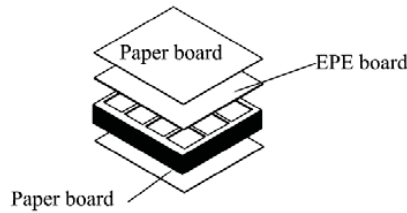
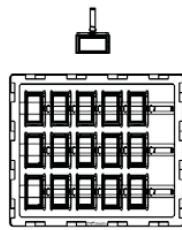

4) Putting in the inner small carton (TYPE:H82)

5) Putting 5 small cartons into one outcarton

6) Packing finished

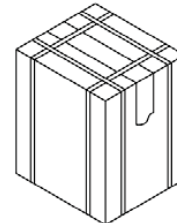
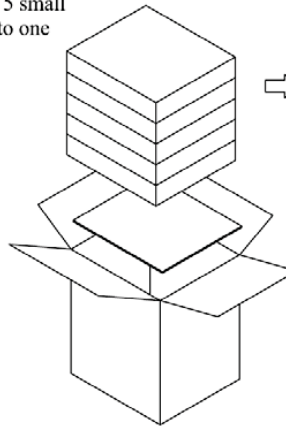
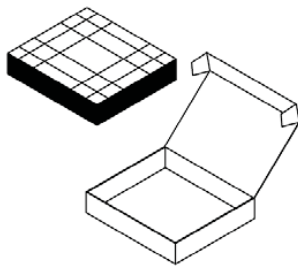

Note: 15 pcs in a tray, 6 trays in a inner carton, 5 inner cartons in a out carton, so 15x6x5=450pcs/Outcarton
 Dimension (Small carton): 385*325*87mm Dimension (Out carton): 394*344*470mm

NO.	YMS12864-20ABFFDGL	Ver. 1	Drw:	Chk:	Apv:
-----	--------------------	--------	------	------	------

DATE MAY.6.2010		TECHNICAL SPECIFICATION
LCM	YMS12864-20ABFFDGL	Page 15 of 17

VII. Precautions For Use

1. Safety

- (1) Do not swallow any liquid crystal, even if there is no proof that liquid crystal is poisonous.
- (2) If the LCD panel breaks, be careful not to get liquid crystal to touch your skin.
- (3) If skin is exposed to liquid crystal, wash the area thoroughly with alcohol or soap.

2. Storage Conditions

- (1) Store the panel or module in a dark place where the temperature is $23\pm 5^{\circ}\text{C}$ and the humidity is below $50\pm 20\% \text{RH}$.
- (2) Store in anti-static electricity container.
- (3) Store in clean environment, free from dust, active gas, and solvent.
- (4) Do not place the module near organics solvents or corrosive gases.
- (5) Do not crush, shake, or jolt the module.
- (6) Do not exposed to direct sun light of fluorescent lamps.

3. Installing LCD Module

Attend to the following items when installing the LCM.

- (1) Cover the surface with a transparent protective plate or touch panel to protect the polarizer and LC cell.
- (2) When assembling the LCM into other equipment, the spacer to the bit between the LCM and the fitting plate should have enough height to avoid causing stress to the module surface, refer to the individual specifications for measurements.

4. Precautions For Operation

- (1) Viewing angle varies with the change of liquid crystal driving voltage (V_0). Adjust V_0 to show the best contrast.
- (2) Driving the LCD in the voltage above the limit will shorten its lifetime.
- (3) Response time is greatly delayed at temperature below the operating temperature range. However, this does not mean the LCD will be out of the order. It will recover when it returns to the specified temperature range.
- (4) When turning the power on, input each signal after the positive/negative voltage

DATE MAY.6.2010			TECHNICAL SPECIFICATION
LCM		YMS12864-20ABFFDGL	Page 16 of 17

becomes stable.

(5) Do not apply water or any liquid on product which composed of T/P.

5.Handling Precautions

(1) Avoid static electricity which can damage the CMOS LSI; please wear the wrist strap when handling.

(2) The polarizing plate of the display is very fragile. so, please handle it very carefully.

(3) Do not give external shock.

(4) Do not apply excessive force on the surface; it may cause display abnormal .

(5) Do not wipe the polarizing plate with a dry cloth, as it may easily scratch the surface of plate.

(6) Do not use ketonics solvent & Aromatic solvent, use with a soft cloth soaked with a cleaning naphtha solvent.

(7) Do not operate it above the absolute maximum rating.

(8) Do not remove the panel or frame from the module.

(9) Do not apply water or any liquid on product which composed of T/P.

DATE MAY.6.2010			TECHNICAL SPECIFICATION
LCM		YMS12864-20ABFFDGL	Page 17 of 17