



Colour TFT Display Modules

Product Specification

Part No. LCF1506188GGU00

15.6" WXGA Colour TFT Display
with PCAP Touchscreen

For more information, please visit www.andersdx.com
or email info@andersdx.com

Version 1

DATA IMAGE CORPORATION

CTP Module Specification

Preliminary

ITEM NO.: LCF1506188GGU00

Table of Contents

1. COVER & CONTENTS	1
2. RECORD OF REVISION	2
3. GENERAL SPECIFICATIONS	3
4. LCD ABSOLUTE MAXIMUM RATINGS.....	3
5. LCD ELECTRICAL CHARACTERISTICS	4
6. LCD INTERFACE SPECIFICATIONS	6
7. LCD PIN ASSIGNMENT	10
8. CTP SPECIFICATIONS	12
9. OPTICAL CHARACTERISTIC	13
10. QUALITY ASSURANCE	16
11. APPEARANCE SPECIFICATION	17
12. PRODUCT LABEL DEFINE	20
13. PRECAUTIONS IN USE LCM	22
14. OUTLINE DRAWING	23
15. PACKAGE INFORMATION	24

Customer Companies	R&D Dept.	Q.C. Dept.	Eng. Dept.	Prod. Dept.
	ALEX	PRETTY	DAVID	KEN
Approved by	Version:	Issued Date:	Sheet Code:	Total Pages:
	1	07/JUL15'		24

3. GENERAL SPECIFICATIONS

Composition: A touch panel module with 15.6 inches Capacitive Touch Panel (CTP).

Parameter	Specifications	Unit
Display resolution	1366(W) x (R,G,B) x768(H)	dot
Screen size	15.6 (diagonal)	inch
Outline dimension	370.4(W) x 227.89(H) x19.8(D)	mm
Display active area	344.232 (W) x 193.536 (H)	mm
Sensor active area	346.23(W) x 195.54(D)	mm
Dot pitch	0.084 x 0.252	mm
Display mode	TN Mode, Normally White	
Surface treatment	Glare, 7H	
Weight	TBD	g
View angle direction(gray inversion)	All	
LCM part number	FG150610DSSWNGL2	
Our components and processes are compliant to RoHS. standard		

4. LCD ABSOLUTE MAXIMUM RATINGS

GND=0V

Parameter	Symbol	MIN.	MAX.	Unit	Remark
Logic Input Voltage	V _{IN}	-0.3	4.0	V	Note1
Operating Temperature	Top	0	70	°C	
Storage Humidity	H _{op}	5	90	%	
Storage Temperature	T _{st}	-20	70	°C	
Storage Humidity	H _{st}	5	90	%	

Note 1: With in T_a (25°C)

Note 2: Permanent damage to the device may occur if exceeding maximum values

Note 3: For quality performance, please refer to DI IIS(Incoming Inspection Standard).

Note 4: Operation Temperature + 60°C is defined as panel surface temperature.

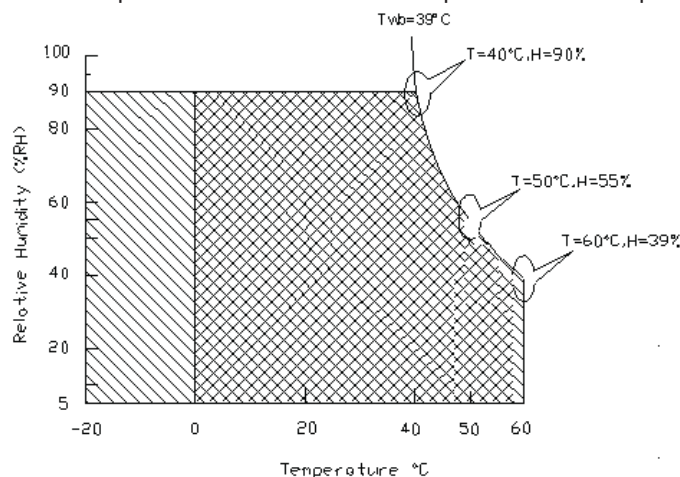

Operating Range



Storage Range

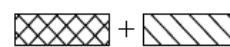

5. LCD ELECTRICAL CHARACTERISTICS

5.1 Typical Operation Conditions

Item	Symbol	Values			Unit	Remark
		Min.	Typ.	Max.		
Logic/LCD Drive voltage	Vin	4.5	5.0	5.5	V	+/-10%
Input Current	IDD	-	0.43	0.5	A	VDD=5.0V, All Black Pattern At 60Hz
VDD Power	PDD	-	2.15	2.5	W	
Inrush Current	IRush	-	-	2.5	A	Note 1
Allowable Logic/LCD Drive Ripple Voltage	VDDrp	-	-	300	mV	VDD=5.0V, All Black Pattern At 60Hz

Note1 : Measurement conditions:

The duration of rising time of power input is 470 us.

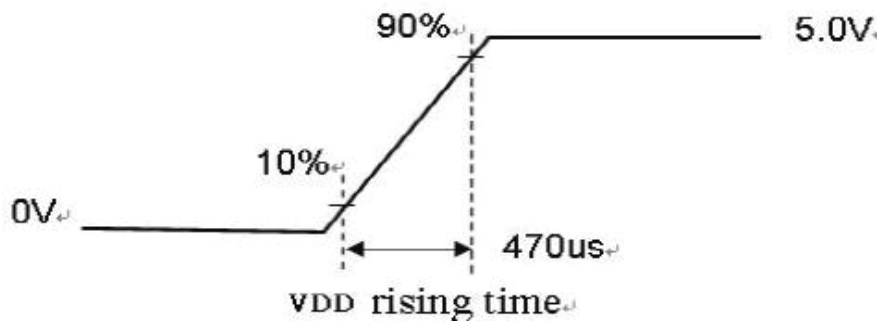
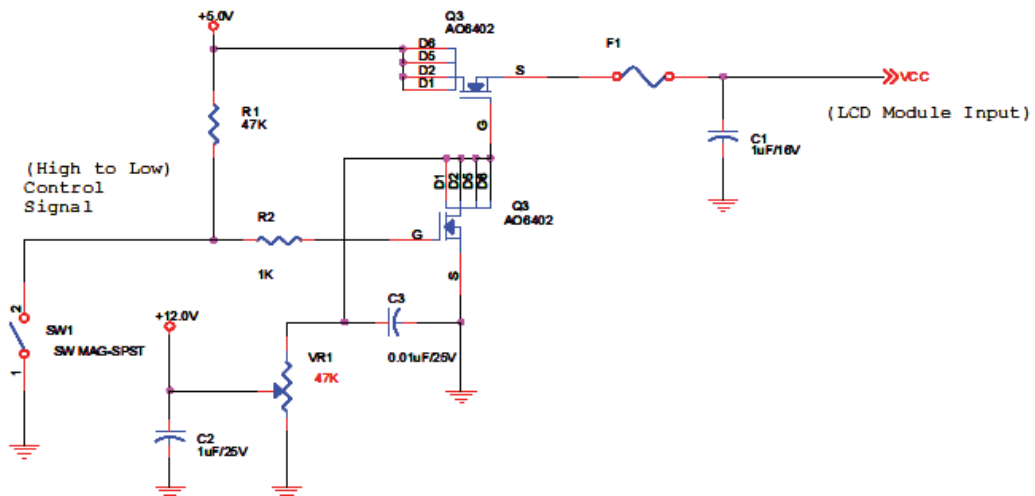

5.2 Signal Electrical Characteristics

Input signals shall be low or Hi-Z state when VDD is off. Please refer to specifications of SN75LVDS82DGG (Texas Instruments) in detail.

Item	Symbol	Values			Unit	Remark
		Min.	Typ.	Max.		
Differential Input High Threshold	VTH	-	+50	+100	mV	VICM = 1.2V
Differential Input Low Threshold	VTL	-100	-50	-	mV	Note 1
Input Differential Voltage	VID	100	-	600	mV	Note 1
Differential Input Common Mode Voltage	VICM	+1.0	+1.2	+1.5	V	VTH-VTL =200MV(max) Note 1

Note 1: LVDS Signal Waveform

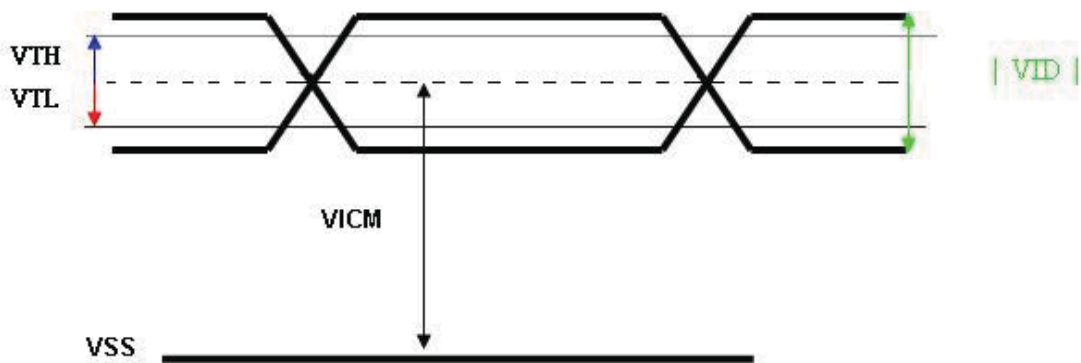

5.3 Backlight Driving Conditions

Item	Symbol	Values			Unit	Remark
		Min.	Typ.	Max.		
LED Forward Voltage	VF	33	-	39.6	V	Ta=25°C
LED Forward Current	IF	-	480	-	mA	
LED Life Time		TBD	-	-	Hrs	

Note 1: Ta means ambient temperature of TFT-LCD module.

Note 2: The module is driven at high ambient temperature & humidity condition. The operating life will be reduced.

Note 3: Operating life means brightness goes down to 50% initial brightness. Min. operating life time is estimated data.

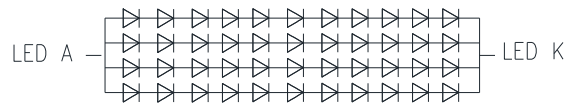

VF : 33~39.6 V
IF : 120mA *4=480mA

6. LCD INTERFACE SPECIFICATIONS

6.1 Timing Characteristics

Basically, interface timing described here is not actual input timing of LCD module but close to output timing of SN75LVDS82DGG (Texas Instruments) or equivalent.

Item	Symbol	Value			Unit	Remark	
		Min.	Typ.	Max.			
Data CLK	Tclk	60	76	90	MHz		
H-section	Period	T _H	1446	1560	1936	Tclk	
	Display Area	T _{HD}	1366			Tclk	
	Blanking	T _{HB}	80	200	570	Tclk	
V-section	Period	T _V	778	806	888	Th	
	Display Area	T _{VD}	768			Th	
	Blanking	T _{VB}	10	38	120	Th	
Frame Rate	F	50	60	75	Hz		

Note : DE mode only.

6.2 Timing diagram

Confidential Document

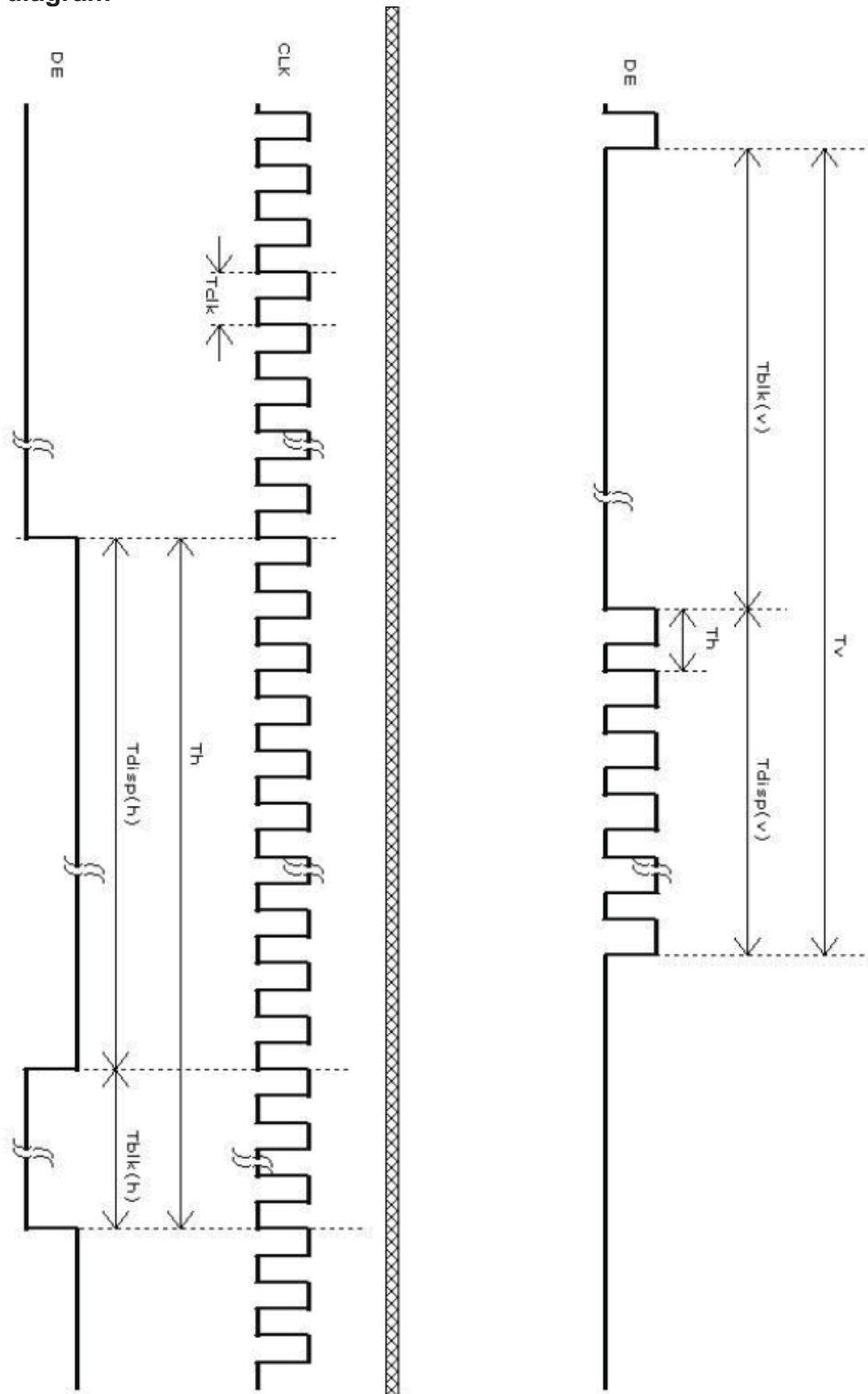

6.3 Power ON/OFF Sequence

VDD power and LED on/off sequence are as follows. Interface signals are also shown in the chart. Signals from any system shall be Hi-Z state or low level when VDD is off.

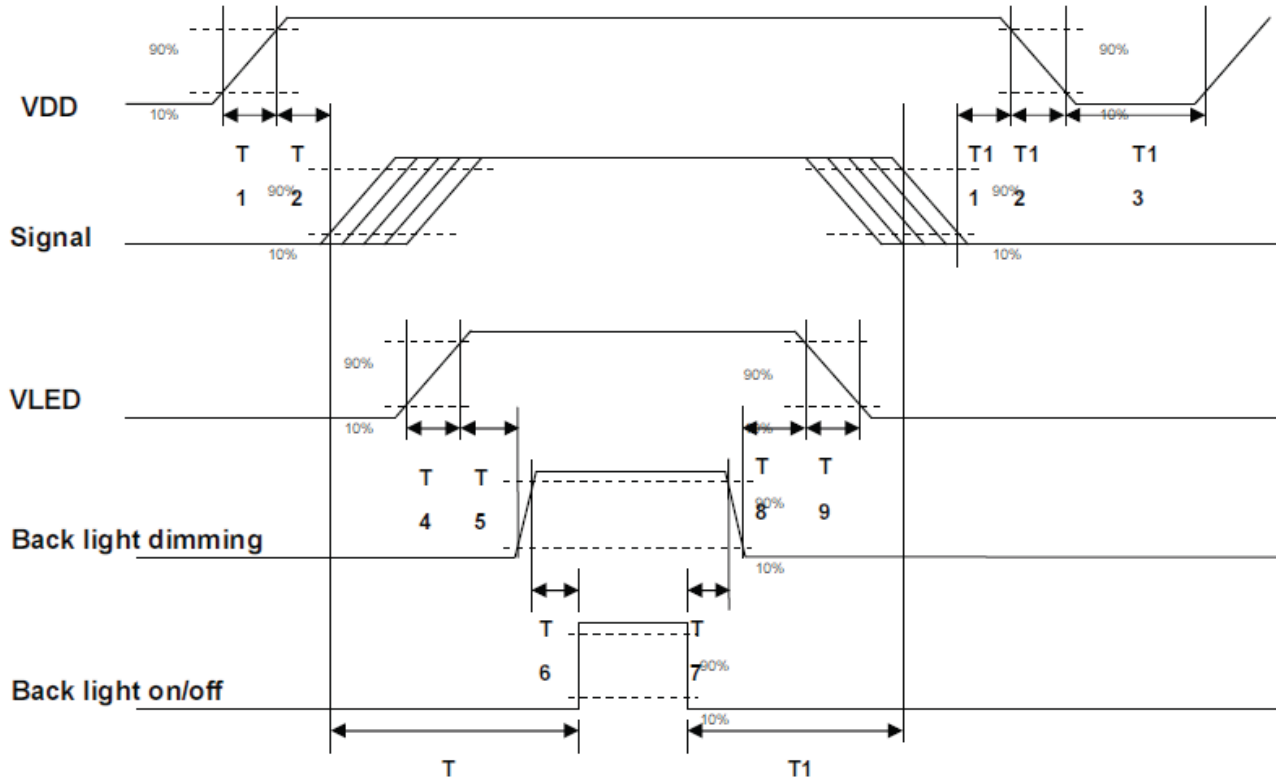

Parameter	Value			
	Min.	Typ.	Max.	Units
T1	0.5	-	10	ms
T2	0	40	50	ms
T3	200	-	-	ms
T4	0.5	-	10	ms
T5	10	-	-	ms
T6	10	-	-	ms
T7	0	-	50	ms
T8	10	-	-	ms
T9	-	-	10	ms
T10	110	-	-	ms
T11	0.5	16	50	ms
T12	-	-	100	ms
T13	1000			

6.4 Pixel Format Image

Following figure shows the relationship of the input signals and LCD pixel format.

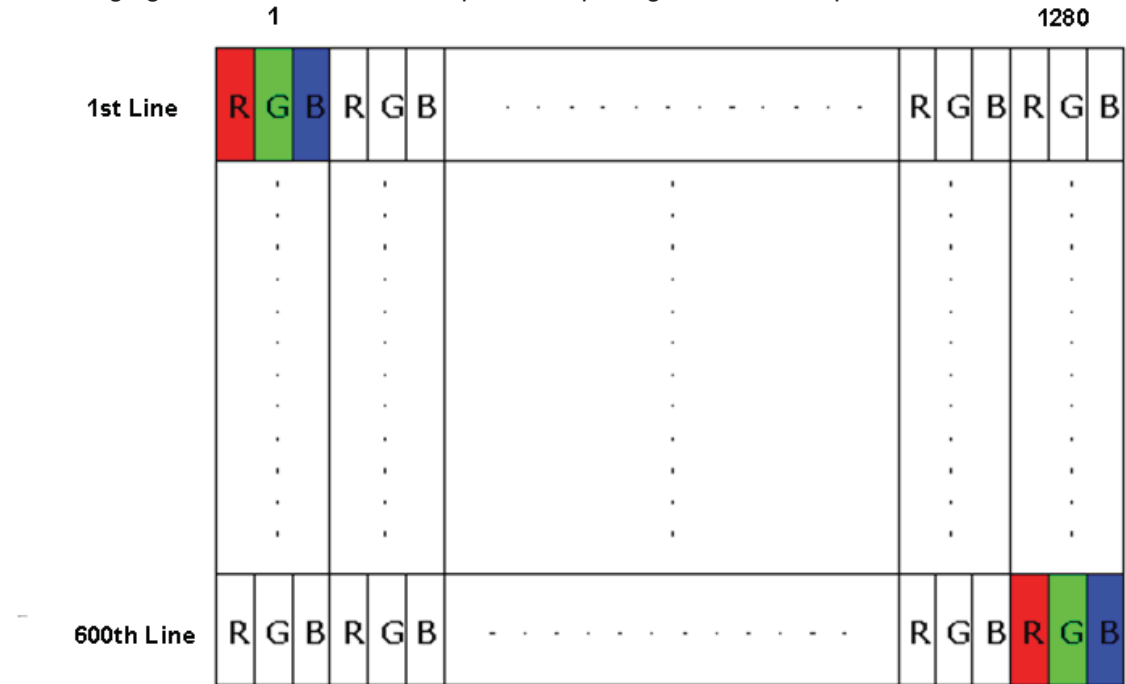

6.5 The Input Data Format

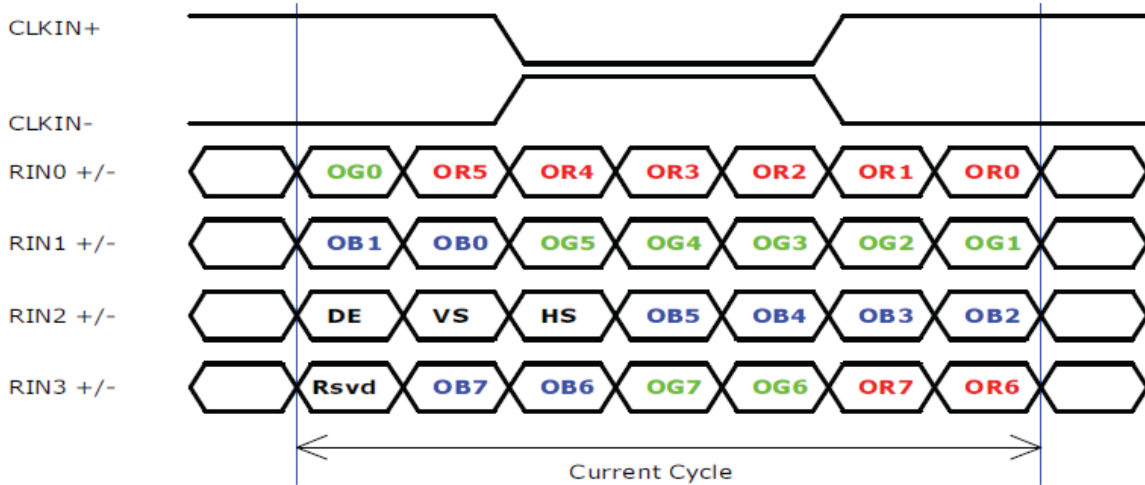

Note 1: R/G/B data 7:MSB, R/G/B data 0:LSB

7. LCD PIN ASSIGNMENT

7.1 TFT Module

Pin No.	Symbol	Function	Remark
1	Reserved	No Connection	
2	Reserved	No Connection	
3	Reserved	No Connection	
4	GND	Ground	
5	RXIN0-	-LVDS Differential Data Input, CH0	
6	RXIN0+	+LVDS Differential Data Input, CH0	
7	GND	Ground	
8	RXIN1-	-LVDS Differential Data Input, CH1	
9	RXIN1+	+LVDS Differential Data Input, CH1	
10	GND	Ground	
11	RXIN2-	-LVDS Differential Data Input, CH2	
12	RXIN2+	+LVDS Differential Data Input, CH2	
13	GND	Ground	
14	RXCLKIN-	-LVDS Differential Clock Input, CH3	
15	RXCLKIN+	+LVDS Differential Clock Input, CH3	
16	GND	Ground	
17	RXIN3-	-LVDS Differential Data Input, CH3	
18	RXIN3+	+LVDS Differential Data Input, CH3	
19	GND	Ground	
20	Reserved	No Connection	
21	Reserved	No Connection	
22	Reserved	No Connection	
23	GND	Ground	
24	GND	Ground	
25	GND	Ground	
26	AVDD	Power +5V, (typical)	
27	AVDD	Power +5V, (typical)	
28	AVDD	Power +5V, (typical)	
29	AVDD	Power +5V, (typical)	
30	AVDD	Power +5V, (typical)	

7.2 Backlight

Pin No.	Symbol	Pin No.	Symbol
1	A	5	K
2	A	6	K
3	A	7	K
4	K	8	NC

7.3 Block Diagram

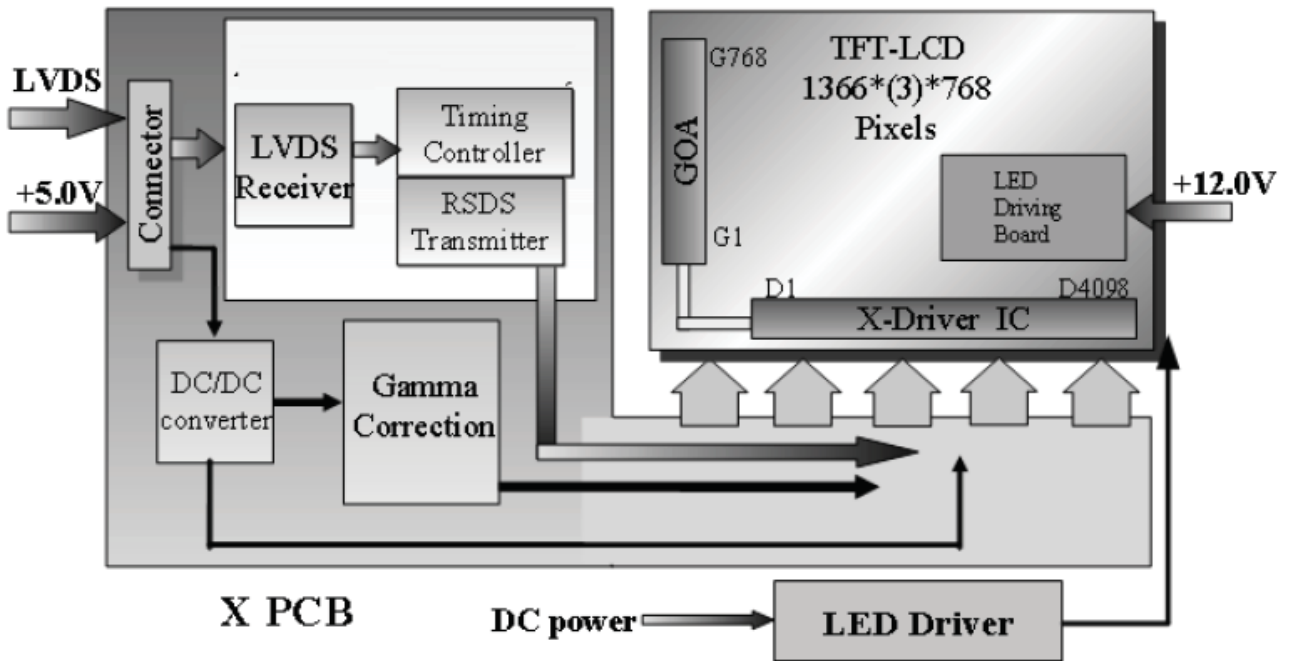

8. CTP SPECIFICATIONS

8.1 CTP General Specifications

Composition: It's 15.6 inch Capacitive Touch Panel (CTP).

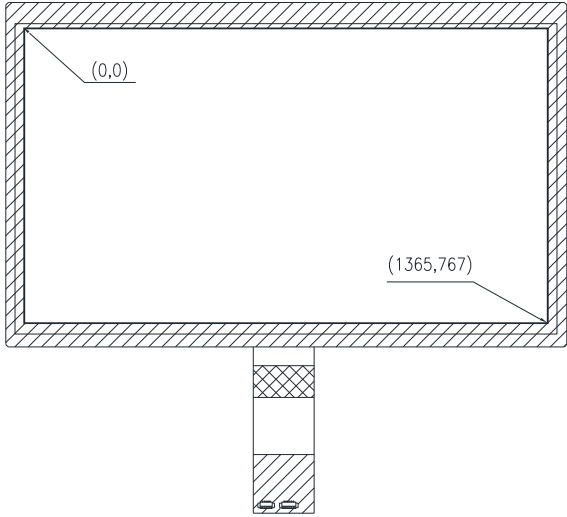
Item	Specification	Unit
Type	Transparent type projected capacitive touch panel	
Input mode	Human's finger	
Multi touch	2	Point
Interface	USB	
(X,Y) Position		

8.2 Absolute Maximum Rating

Symbol	Description	Min	Typ.	Max	Unit	Notes
VCC	Supply voltage	-0.5	-	6	V	
VIO	Input I/O pin voltage	GND-0.3	-	VCC+0.3	V	

8.3 Electrical Characteristic

Symbol	Description	Min	Typ.	Max	Unit	Notes
VCC	Supply voltage	4.75	5	5.25	V	USB 5V

8.4 Pin Connections

Pin Number	Pin Name	Description
1	GND	Ground
2	VDD	Power Supply Voltage, USB 5V
3	GND	Ground
4	D+	USB data+
5	D-	USB data -

9. OPTICAL CHARACTERISTIC

Item	Symbol	Condition	Values			Unit	Remark
			Min.	Typ.	Max.		
Viewing angle (Center CR \geq 10 or CR \geq 5)	-	Horizontal (Right) CR \geq 10 (Left)	75	85	-	degree	Note 1,2
		Vertical (Up) CR \geq 10 (Down)	70	80	-		
		Horizontal (Right) CR \geq 5 (Left)	75	85	-		
		Horizontal (Right) CR \geq 5 (Left)	75	85	-		
		Horizontal (Right) CR \geq 5 (Left)	75	85	-		
		Horizontal (Right) CR \geq 5 (Left)	75	85	-		
		Horizontal (Right) CR \geq 5 (Left)	75	85	-		
Response Time	-	Raising Time (T _{rR})	-	6	9	msec	Note 4
		Falling Time (T _{rF})	-	2	4		
		Raising + Falling	-	8	13		
Contrast ratio	CR	Normal $\theta=\Phi=0^\circ$	300	425	-	-	Note 3
Chromaticity	x _w	Center $\theta_x=\theta_y=0^\circ$	Typ-	0.25	Typ+		
	y _w		0.05	0.295	0.05		
Luminance	L		815	1020	-	cd/m ²	Note 5
Luminance Uniformity	-	9 Points	70	75	--	%	Note 6
Crosstalk			-	-	1.5	%	Note 7

Note 1: Measurement method

The LCD module should be stabilized at given temperature for 30 minutes to avoid abrupt temperature change during measuring (at surface 35°C). In order to stabilize the luminance, the measurement should be executed after lighting Backlight for 30 minutes in a stable, windless and dark room.

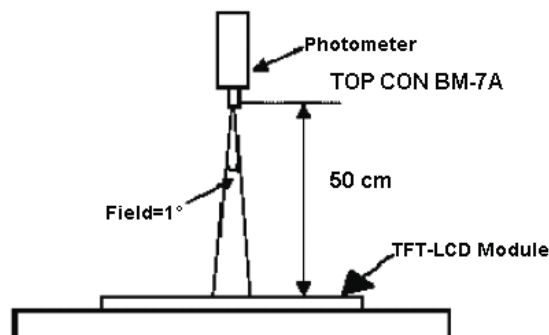

Note 2: Definition of viewing angle measured by TOP CON BM-7A.

Viewing angle is the measurement of contrast ratio ≥ 10 and ≥ 5 , at the screen center, over a 180° horizontal and 180° vertical range (off-normal viewing angles). The 180° viewing angle range is broken down as follows; 90° (Θ) horizontal left and right and 90° (Φ) vertical, high (up) and low (down).

The measurement direction is typically perpendicular to the display surface with the screen rotated about its center to develop the desired measurement viewing angle.

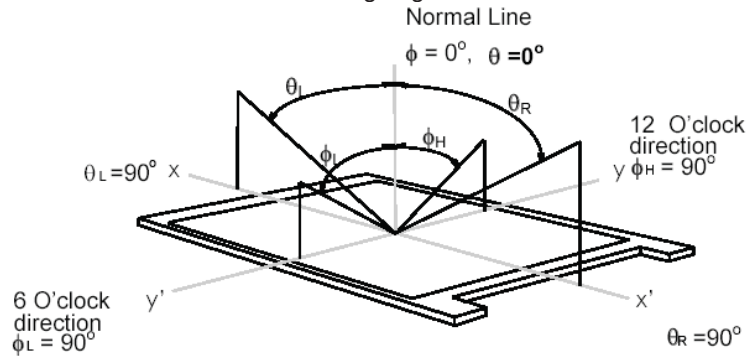

Note 3: Contrast ratio is measured by TOP CON BM-7A.

Note 4: Definition of Response time measured by TOP CON BM-7A.

The output signals of photo detector are measured when the input signals are changed from “Full Black” to “Full White” (rising time, Tr_R), and from “Full White” to “Full Black” (falling time, Tf_F), respectively. The response time is interval between the 10% and 90% (1 frame at 60 Hz) of amplitudes.

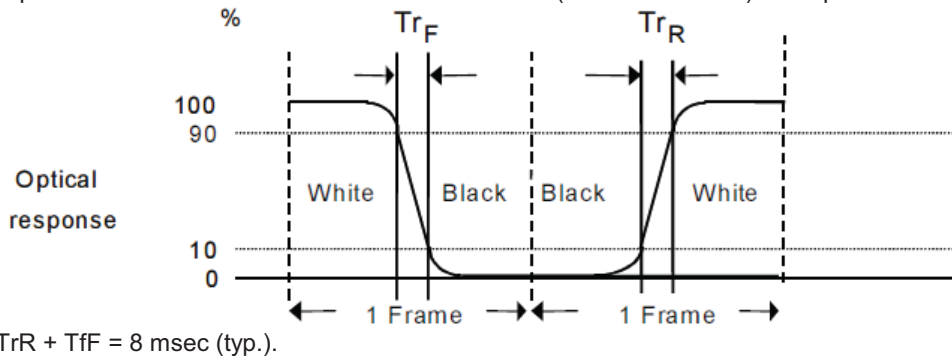

Note 5: Central luminance is measured by TOP CON BM-7A.

Note 6: Luminance uniformity of these 9 points is defined as below and measured by TOPCON SR-3

Maximum Luminance in 9 Points (1- 9) Uniformity

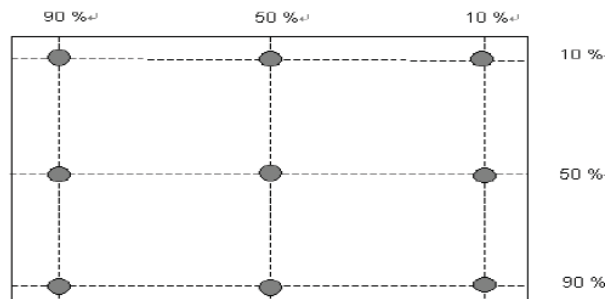

$$\text{Uniformity} = \frac{\text{Minimum Luminance in 9 points (1-9)}}{\text{Maximum Luminance in 9 Points (1-9)}}$$

Note 7: Crosstalk is defined as below and measured by TOP CON BM-7A.

$CT = |YB - YA| / YA \times 100 (\%)$, Where

YA = Luminance of measured location without gray level 0 pattern (cd/m²)

YB = Luminance of measured location with gray level 0 pattern (cd/m²)

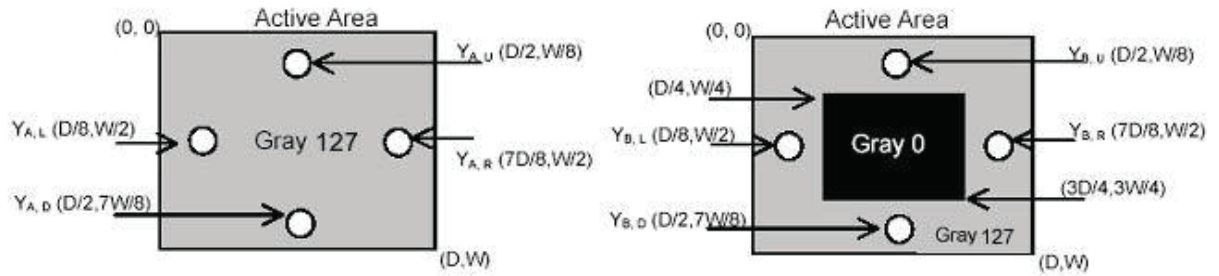



10. QUALITY ASSURANCE

10.1 Test Condition

10.1.1 Temperature and Humidity (Ambient Temperature)

Temperature : $25 \pm 5^{\circ}\text{C}$

Humidity : $65 \pm 5\%$

10.1.2 Operation

Unless specified otherwise, test will be conducted under function state.

10.1.3 Container

Unless specified otherwise, vibration test will be conducted to the product itself without putting it in a container.

10.1.4 Test Frequency

In case of related to deterioration such as shock test. It will be conducted only once.

10.1.5 Test Method

Reliability Test Item & Level			Remark
No.	Test Item	Test Level	
1	High Temperature Storage Test	Ta=70°C, 300hrs	IEC68-2-2
2	Low Temperature Storage Test	Ta=-20°C, 300hrs	IEC68-2-1
3	High Temperature Operation Test	Ts=70°C, 300hrs	IEC68-2-2
4	Low Temperature Operation Test	Ta=0°C, 300hrs	IEC68-2-1
5	High Temperature and High Humidity Operation Test	T=50°C,80%RH,300hrs	IEC68-2-2
6	Thermal Cycling Test (No operation)	-20°C → +60°C 30min 30min, 100 cycles	IEC68-2-14
7	ESD Test	State: operating Location: LCM/TP surface Condition:150pf 330Ω Contact +/- 4kV Air +/-8kV Criteria: Class C	IEC 6100-4-2

11. APPEARANCE SPECIFICATION

11.1 Inspection condition

11.1.1 Inspection conditions

11.1.1.1 Inspection Distance : 30 ± 5 cm

11.1.1.2 View Angle :

(1) Inspection that light pervious to the product: $90 \pm 15^\circ$

(2) Inspection that light reflects on the product: $90 \pm 15^\circ$

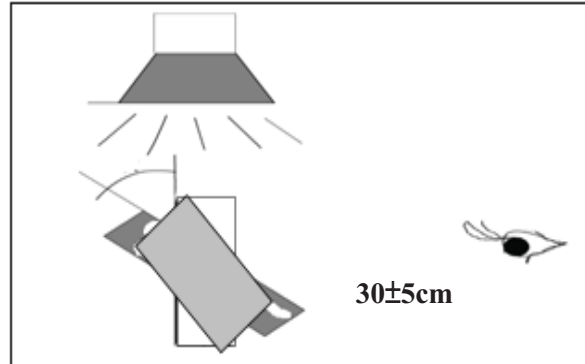
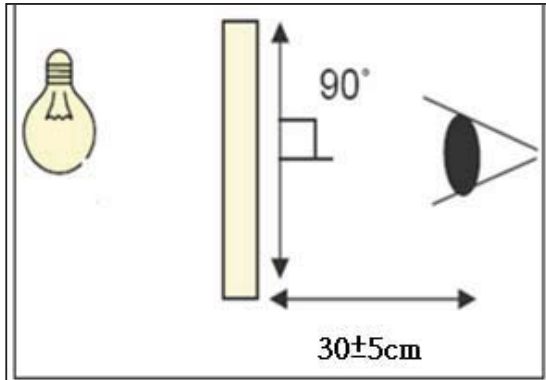



11.1.2 Environment conditions

Ambient Temperature :	$25 \pm 5^\circ\text{C}$
Ambient Humidity :	30~75%RH
Ambient Illumination	600~800 lux

11.2 Inspection Parameters

Appearance inspection standard (D: diameter, L: length; W: width, Z: height, T: glass thickness)

Inspection item	Inspection standard	Description
No image	Prohibited	
Image abnormal	Prohibited	
Bright line	Prohibited	
Thin line	It is acceptable that the defect can not be seen with 10% ND filter.	
Mura	It is acceptable that the defect can not be seen with 5% ND filter.	

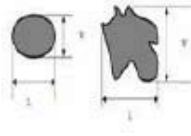
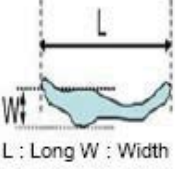
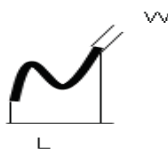
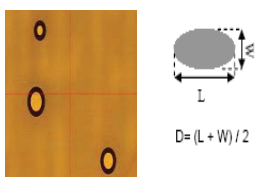
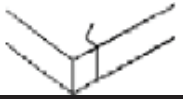
Dot	Item	Acceptable Visible area	Total	One Dot  Two adjacent dot 
	Bright dot	3		
Dark dot	5			
Bright adjacent dots	1	1		
Dark adjacent dots	2	2		
Adjacent dots with a bright dot and a dark dot	2	2		
Foreign material in dot shape	SPEC (unit: mm)	Acceptable	 $D = (L + W) / 2$	
	$D \leq 0.5$	Ignored		
	$0.5 < D \leq 0.8$, distance > 5	$n \leq 5$		
	$D > 0.8$	0		
Foreign material in line shape	SPEC	Acceptable	 L : Long W : Width	
	$W \leq 0.05$ and $L \leq 10$	Ignored		
	$0.05 < W \leq 0.1$, $L \leq 10$, distance > 5	$n \leq 5$		
	$W > 0.1$ or $L > 10$	0		
Contamination	It is acceptable if the dirt can be wiped.			
Scratch	SPEC	Acceptable		
	$W \leq 0.05$ and $L \leq 10$	Ignored		
	$0.05 < W \leq 0.08$, $L \leq 10$, distance > 5	$n \leq 5$		
	$0.08 < W \leq 0.1$, $L \leq 10$, distance > 5	$n \leq 3$		
	$W > 0.1$ or $L > 10$	0		
Bubble	SPEC (unit: mm)	Acceptable	 $D = (L + W) / 2$	
	$D \leq 0.3$	Ignored		
	Non visible area	Ignored		
	$0.3 < D \leq 0.5$, distance > 5	$n \leq 5$		
	$D > 0.5$	0		
Cover & Sensor Crack	Prohibited			

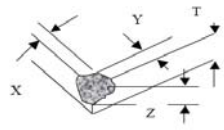
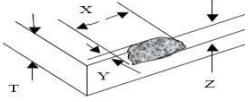
Cover angle missing	SPEC (unit: mm)	Acceptable	
	Side/Bottom	Ignored	
	It is prohibited if the defect appears on the front.	0	
Cover edge break	SPEC (unit: mm)	Acceptable	
	$X \leq 3.0, Y \leq 3.0, Z \leq T$	Ignored	
	$X > 3.0, Y > 3.0, Z > T$	0	
Inspection item	SPEC		Description
Ink	SPEC (unit: mm)	Acceptable	
	word unclear, inverted, mistake, break line	0	
Bubble under protection film	SPEC (unit: mm)	Acceptable	
	NA		
Function	Prohibited		

11.3 Sampling Condition

Unless otherwise agree in written, the sampling inspection shall be applied to the incoming inspection of customer.

Lot size: Quantity of shipment lot per model.

Sampling type: normal inspection, single sampling

Sampling table: MIL-STD-105E

Inspection level: Level II

Class of defects	Definition		
	Major	AQL 0.65	It is a defect that is likely to result in failure or to reduce materially the usability of the product for the intended function.
	Minor	AQL 1.5	It is a defect that will not result in functioning problem with deviation classified.

12. PRODUCT LABEL DEFINE

Product Label style:

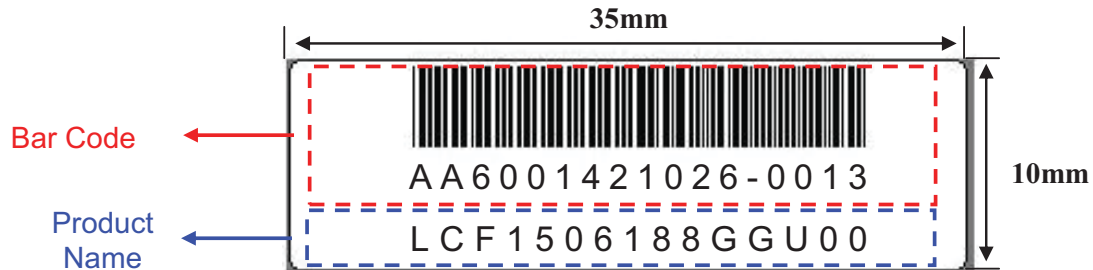

Bar Code Define:

A A 6 0014 2 10 26-0013

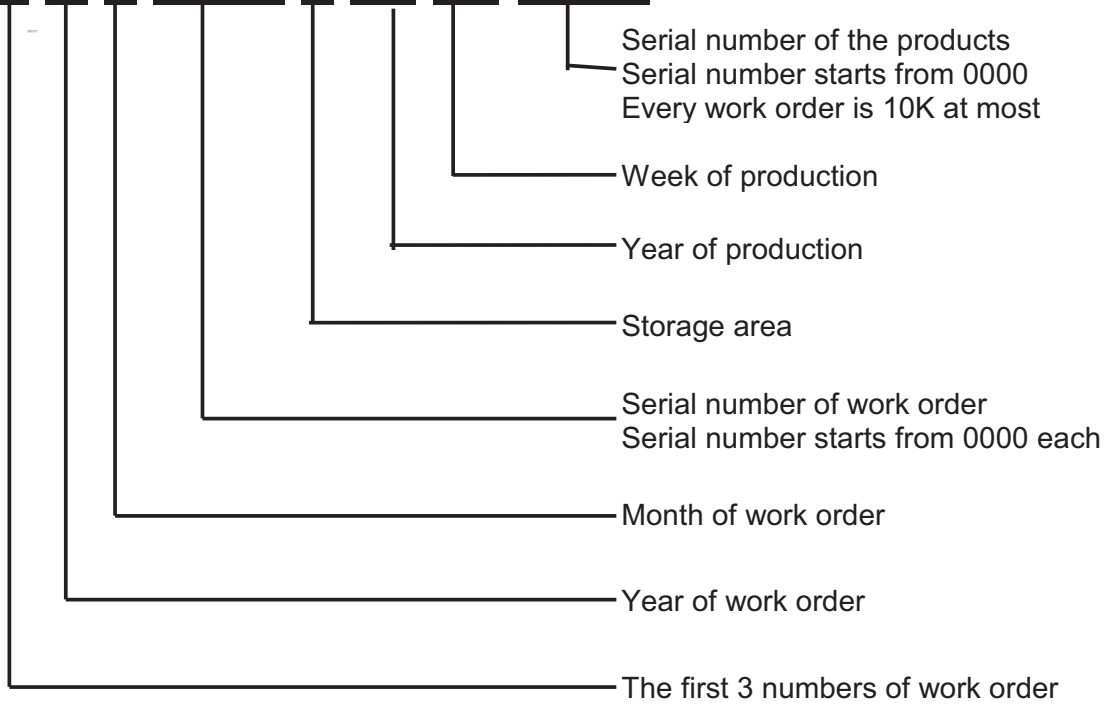



Confidential Document

Product Name Define:

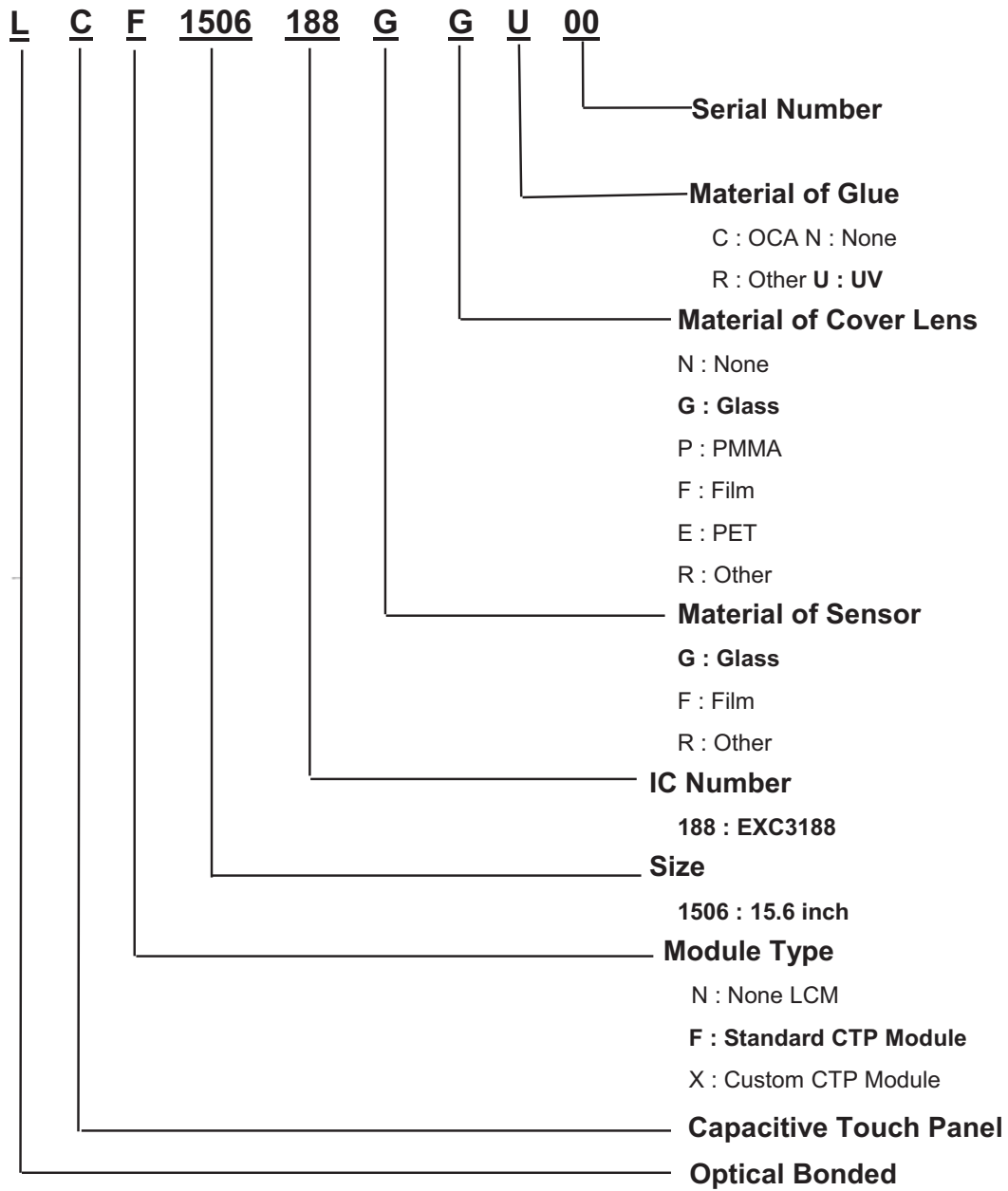



13. PRECAUTIONS IN USE LCM

Confidential Document

1. ASSEMBLY PRECAUTIONS
 - (1) You must mount a module using holes arranged in four corners or four sides.
 - (2) You should consider the mounting structure so that uneven force (ex. Twisted stress) is not applied to the module. And the case on which a module is mounted should have sufficient strength so that external force is not transmitted directly to the module.
 - (3) Do not touch, push or rub the exposed polarizers with glass, tweezers or anything harder than HB pencil lead. And please do not rub with dust clothes with chemical treatment.
 - (4) Wipe off saliva or water drops as soon as possible. Their long time contact with polarizer causes deformations and color fading.
 - (5) Do not open the case because inside circuits do not have sufficient strength.
 - (6) Please do not take a LCD module to pieces and reconstruct it. Resolving and reconstructing modules may cause them not to work well.
 - (7) Please do not touch metal frames with bare hands and soiled gloves. A color change of the metal frames can happen during a long preservation of soiled LCD modules.
 - (8) Please pay attention to handling lead wire of backlight so that it is not tugged in connecting with inverter.
2. OPERATING PRECAUTIONS
 - (1) Please be sure to turn off the power supply before connecting and disconnecting signal input cable.
 - (2) Please do not change variable resistance settings in LCD module. They are adjusted to the most suitable value. If they are changed, it might happen LCD does not satisfy the characteristics specification
 - (3) Be careful for condensation at sudden temperature change. Condensation makes damage to polarizer or electrical contacted parts. And after fading condensation, smear or spot will occur.
 - (4) When fixed patterns are displayed for a long time, remnant image is likely to occur.
 - (5) Module has high frequency circuits. Sufficient suppression to the electromagnetic interference shall be done by system manufacturers. Grounding and shielding methods may be important to minimize the interference.
 - (6) Please consider that LCD backlight takes longer time to become stable of radiation characteristics in low temperature than in room temperature.
3. ELECTROSTATIC DISCHARGE CONTROL
 - (1) The operator should be grounded whenever he/she comes into contact with the module. Never touch any of the conductive parts such the copper leads on the PCB and the interface terminals with any parts of the human body.
4. STORAGE PRECAUTIONS
 - (1) The modules should be kept in antistatic bags or other containers resistant to static for storage.
 - (2) Only properly grounded soldering irons should be used.
 - (3) If an electric screwdriver is used, it should be well grounded and shielded from commutator sparks.
 - (4) The normal static prevention measures should be observed for work clothes and working benches; for the latter conductive (rubber) mat is recommended
 - (5) Since dry air is inductive to statics, a relative humidity of 50-60% is recommended.
5. OTHERS
 - (1) When you store LCDs for a long time, it is recommended to keep the temperature between 0°C-40°C without the exposure of sunlight and to keep the humidity less than 90%RH.
 - (2) Please do not leave the LCDs in the environment of high humidity and high temperature such as 60°C 90%RH
 - (3) Please do not leave the LCDs in the environment of low temperature; below -20°C.
6. LIMITED WARRANTY
 - (1) A strong incident light into LCD panel might cause display characteristics' changing inferior because of polarizer film, color filter, and other materials becoming inferior. Please do not expose LCD module direct sunlight and strong UV rays
 - (2) Please pay attention to a panel side of LCD module not to contact with other materials in preserving it alone.
 - (3) For the packaging box, please pay attention to the followings:
 - (4) Please do not pile them up more than 5 boxes. (They are not designed so.) And please do not turn over.
 - (5) Please handle packaging box with care not to give them sudden shock and vibrations. And also please do not throw them up.
 - (6) Packing box and inner case for LCDs are made of cardboard. So please pay attention not to get them wet. (Such like keeping them in high humidity or wet place can occur getting them wet.)
6. LIMITED WARRANTY

Unless otherwise agreed between DATA IMAGE and customer, DATA IMAGE will replace or repair any of its LCD and LCM which is found to be defective electrically and visually when inspected in accordance with DATA IMAGE acceptance standards, for a period on one year from date of shipment. Confirmation of such date shall be based on freight documents. The warranty liability of DATA IMAGE is limited to repair and/or replacement on the terms set forth above. DATA IMAGE will not responsible for any subsequent or consequential events.

14. OUTLINE DRAWING

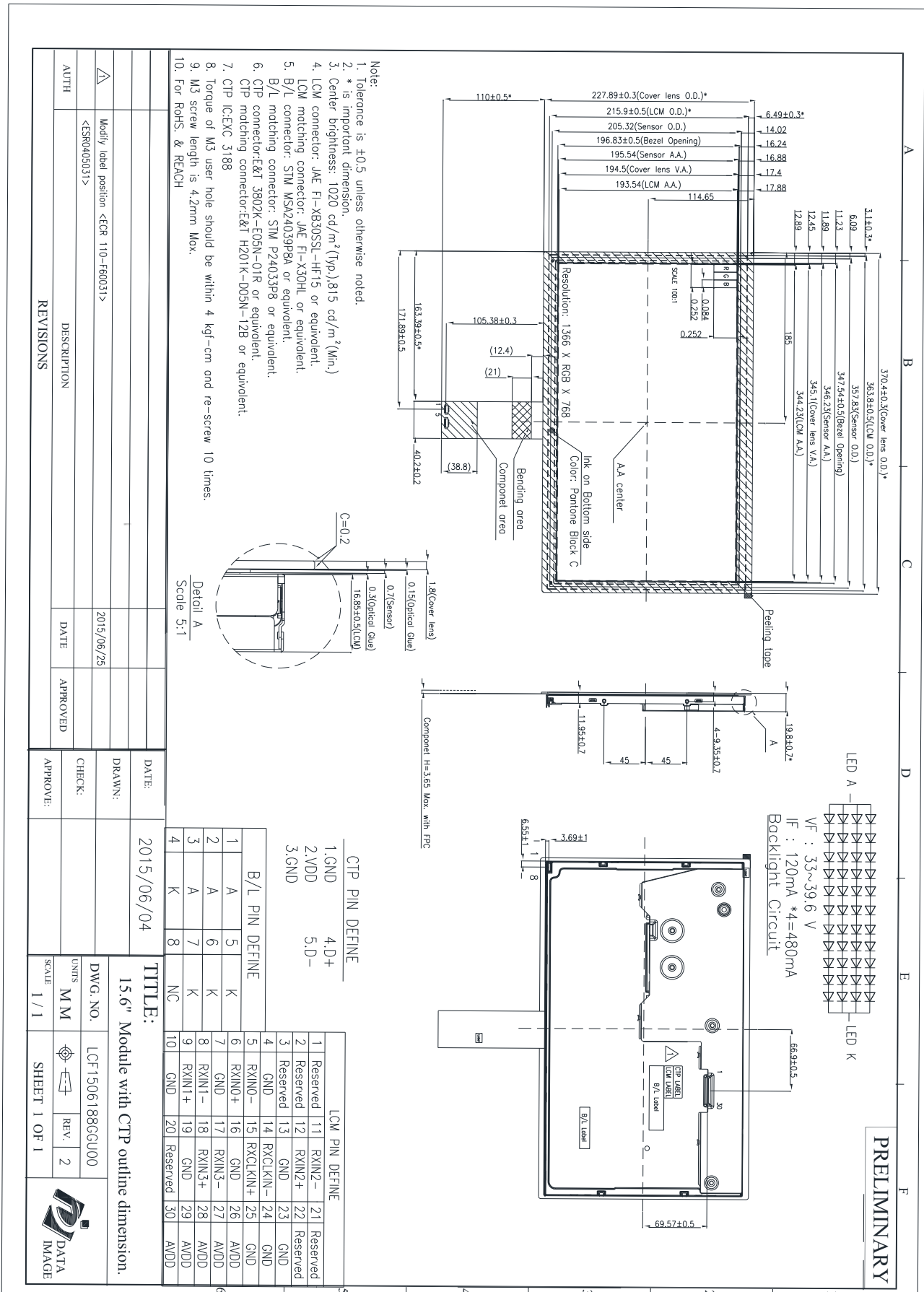

- Note:
1. Tolerance is ±0.5 unless otherwise noted.
 2. * is important dimension.
 3. Center brightness: 1020 cd/m² (Typ.), 815 cd/m² (Min.)
 4. LCM connector: JAE FI-XB30SSL-HF15 or equivalent.
 5. B/L matching connector: JAE FI-X30HL or equivalent.
 6. B/L connector: STM MSA24039P8A or equivalent.
 7. CTP matching connector: STM P24033P8 or equivalent.
 8. CTP connector: E&T 3802K-E05N-01R or equivalent.
 9. CTP matching connector: E&T H201K-D005N-12B or equivalent.
 10. Torque of M3 screw should be within 4 kgf-cm and re-screw 10 times.
 11. M3 screw length is 4.2mm Max.
 12. For RoHS, & REACH

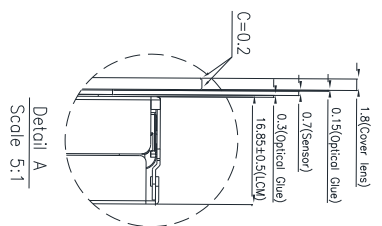

CTP PIN DEFINE

- 1. GND
- 2. VDD
- 3. GND
- 4. D+
- 5. D-

B/L PIN DEFINE

- 1. A
- 2. A
- 3. A
- 4. K
- 5. K
- 6. K
- 7. K
- 8. K
- 9. RXIN1+
- 10. GND
- 11. RXIN2-
- 12. RXIN2+
- 13. GND
- 14. RXCLKIN-
- 15. RXCLKIN+
- 16. GND
- 17. RXIN3-
- 18. RXIN3+
- 19. GND
- 20. Reserved
- 21. Reserved
- 22. Reserved
- 23. GND
- 24. GND
- 25. GND
- 26. AVDD
- 27. AVDD
- 28. AVDD
- 29. AVDD
- 30. AVDD

TITLE: 15.6" Module with CTP outline dimension.

Modify label position <ECR 110-FE0031>	DATE: 2015/06/25	DRAWN:	DATE: 2015/06/04
<ESR0405031>	DATE: 2015/06/25	CHECK:	DATE: 2015/06/04
DESCRIPTION	DATE	APPROVED	DATE
AUTH	DATE	APPROVED	DATE

REVISIONS	DATE	APPROVED	DATE

DWG. NO.	LCF1506188GGU00	SCALE	1/1
UNITS	MM	REV.	2
SHEET	1 OF 1	DATA IMAGE	

15. PACKAGE INFORMATION

TBD