

Anders Product Specification

Manufacturer	Yes Optoelectronics Co.,LTD
Manufacturer Part n°	YTSA10WLAI-03-201C
Anders Part n°	YTSA10WLAI-03-201C
Customer Part n°	n/a
Specification Revision n°	1.0
Issue Date	12/November/2018

Specification Approval

Company name	
Product/Project Name	
Printed name	
Job title	
Signature	
Approval Stage:	<p>This product is approved for the following production stage:</p> <p><input type="checkbox"/> Sample / Prototype</p> <p><input type="checkbox"/> Pre-Production</p> <p><input type="checkbox"/> Mass Production</p>
Approval Date	

Supplied by Anders Electronics plc

PRODUCT : LCD MODULE
MODEL NO : YTSA10WLAI-03-201C
SUPPLIER : Yes Optoelectronics Co.,Ltd
DATE : Nov.12.2018

SPECIFICATION

Prepared by	Checked	Approved
LIANGYUEYAO	XIEMINGLIANG	XIAOYU

CUSTOMER:
MODEL NO.:

DATE:

Prepared by	Checked	Approved

ADD: No.288Yueling Road Anshan,Liaoning,CHINA
TEL: 86-412-5211859 FAX: 86-412-5211729 P.C.:114045
E-mail : yes@yes-lcd.com, yeslcd@globalsources.com
Web: <http://www.yes-lcd.com>
<http://www.asiansources.com/sante.com>

CONTENTS

1.General Specifications	4
2.Mechanical Drawing.....	5
3.PIN Assignment	6
4.Absolute Maximum Rating.....	7
5.Electrical Characteristics.....	7
5.1.Recommended Operating Condition	7
5.2.Recommended driving condition for backlight	7
6. Optical Characteristics	8
7.Environmental/Reliability Test.....	12
8.Packing Drawing.....	13
9. Standard Specifications For Product Quality.....	14
10.Precautions for Use of LCD Modules.....	18
11.Prior Consult Matter.....	22
12.Factory.....	22

Revision Record

Rev No.	Rev Date	Contents	Page
1.0	2018.11.12	New creation	All

1. General Specifications

No	Item	Contents	Unit
1	Size	10.1	inch
2	Resolution	1280RGB*800	
3	Color depth	16.7M	
4	Interface	HDMI	
5	Technology Type	a-Si TFT active matrix	
6	Pixel Pitch	0.1695*0.1695	mm
7	Pixel Arrangement	R.G.B Stripe	
8	Display Mode	Transmissive	
9	Surface treatment	Glare	
10	Viewing Direction	FREE	o'clock
11	LCM (W x H x D)	304*165*11.525	mm
12	Active Area (W x H)	216.96*135.60	mm
13	With/Without TSP	With CTP	
14	LED number	32	

Touch panel parameter

No	Features	Details	Note
1	CTP Technology	Mutual capacitor	
2	Input Method	Finger	
3	Touch point	5Point	
4	Positional Accuracy	2.5mm at 4 edges and 1.5mm at center	Unit: mm
5	Cover glass	Sodalime glass, chemically hardened	
6	Surface treatment	NO	
7	Optical transmittance	87%	
8	Touch controller	ILI2511	
9	Connection Type	ZIF Connector	

2. Mechanical Drawing

CUSTOMER'S APPROVED:	DATE:	PAGE:
-----------------------------	--------------	--------------

1	Operating Voltage:	5V
2	Resolution:	1280RGB*800
3	Interface:	HDMI
4	Display type:	Transmissive
5	Viewing Direction:	Free
6	Operating Temp:	-20°C~60°C
7	Storage Temp:	-40°C~85°C
8	Unspecified tolerance:	±0.3
9	Surface Luminance:	800cd/m ² (min.)

BACKLIGHT CIRCUIT DIAGRAM
Vf=24V (typ.) @ If=135mA

1	+5V
2	GND
3	PHM

1	NC
2	Data-
3	Data+
4	NC
5	GND

TOP VIEW

*304.00±0.2 LENS OD

218.00 LENS VA

216.96 (Active Area)

BLACK PRINTING ON BACK GLASS

43.52

13.00

14.7

135.60 (Active Area)

136.60 LENS VA

14.2

*165.00±0.2 LENS OD

14.20

4.98 (0.00)

0.00

0.75MM

0.30±0.05

0.2±0.3mm

Optical bond

6.2±0.50

1.6±0.50(PCB)

-2±0.50(Sponge)

0.55 SENSOR

0.175 LOKA

1.10 LENS

0.83±0.2 (Final Glass)

Yes Optoelectronics Co., Ltd.

No. YTSA10WLAI-03-201C

Ver. 1

Drew 解明亮 2018.03.22

UNIT: mm

CHK

DESCRIPTION

DATE

NO.		

J1 (HDMI)

PIN SYMBOL	PIN SYMBOL
1 TX2+	11 TXC_SHIELD
2 TX2_SHIELD	12 TXC-
3 TX2-	13 CEC
4 TX1+	14 UTILITY
5 TX1_SHIELD	15 DDCLK
6 TX1-	16 DDAT
7 TX0+	17 GND
8 TX0_SHIELD	18 NC
9 TX0-	19 HOTPLUS
10 TXC+	

3. PIN Assignment

J1(HDMI)

Pin No	Symbol
1	TX2+
2	TX2_SHIELD
3	TX2-
4	TX1+
5	TX1_SHIELD
6	TX1-
7	TX0+
8	TX0_SHIELD
9	TX0-
10	TXC+
11	TXC_SHIELD
12	TXC-
13	CEC
14	UTILITY
15	DDCLK
16	DDAT
17	GND
18	NC
19	HOTPLUS

J4(USB)

Pin No	Symbol
1	NC
2	Data-
3	Data+
4	NC
5	GND

J2

Pin No	Symbol
1	+5V
2	GND

4. Absolute Maximum Rating

AGND = GND = 0V , Ta = 25° C

Item	Symbol	Min	Max	Unit	Remark
Operating Temperature	T _{OPR}	-20	60	° C	
Storage Temperature	T _{STG}	-40	85	° C	

The absolute maximum rating values of this product are not allowed to be exceeded at any times. Should a module be used with any of the absolute maximum ratings exceeded, the characteristics of the module may not be recovered, or in an extreme case, the module may be permanently destroyed.

5. Electrical Characteristics

5.1. Recommended Operating Condition

AGND = GND = 0V , Ta = 25° C

Item	Min	Typ.	Max	Unit	Remark
Power Voltage		5		V	
Total current		1.43		A	
Total consumption		7.15		W	
HDMI consumption		2.21		W	
CTP consumption		0.356		W	
TFT+BL consumption		4.584		W	

5.2. Recommended Driving Condition for Backlight

Ta = 25° C

Item	Symbol	Min	Typ.	Max	Unit	Remark
Forward Voltage	V _f		24		V	
Forward Current	I _f		135		mA	
Operating Life Time	-	20000			Hours	

Note 1: The LED supply voltage is defined by the number of LED at Ta=25°C and I_f= 135 mA.

Note 2: The “Operating Life Time” is defined as the module brightness decrease to 50% original brightness at Ta=25°C and I_f=135mA. The LED lifetime could be decreased if operating I_f is larger than 135 mA.

6. Optical Characteristics

Item	Symbol	Condition	Min	Typ	Max	Unit	Remark
View Angles	θT	$CR \geq 10$		85		Degree	Note 2
	θB			85			
	θL			85			
	θR			85			
Contrast Ratio	CR	$\theta = 0^\circ$	600	800			Note 1 Note 3
Response Time	T_{ON}	$25^\circ C$		30		ms	Note 1
	T_{OFF}						Note 4
Chromaticity	W_x	x	0.289	0.319	0.349		Note 1
	W_y	y	0.335	0.365	0.365		Note 5
Uniformity	U		75			%	Note 5
Luminance	L		800			cd/m ²	Note 1 Note 5

Test Conditions:

1. Operating voltage= 5V, the ambient temperature is $25^\circ C$.
2. The test systems refer to Note 2.

Note1: Definition of optical measurement system.

The optical characteristics should be measured in dark room. After 5Minutes operation, the optical properties are measured at the center point of the LCD screen. ALL input terminals LCD panel must be ground when measuring the center area of the panel.

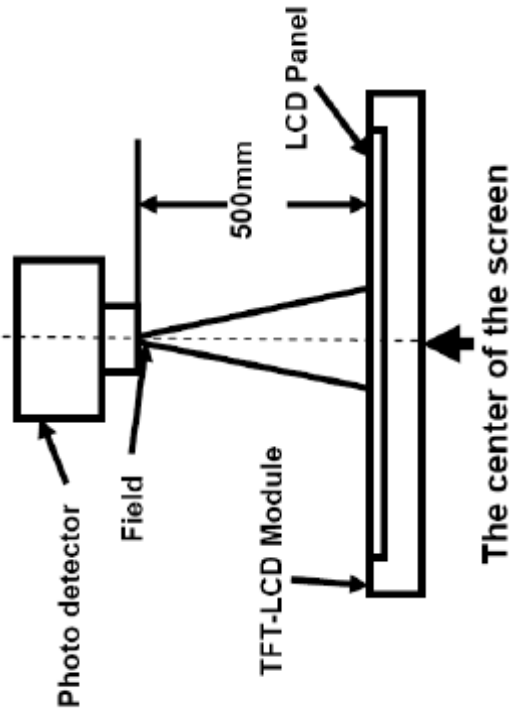

Item	Photo detector	Field
Contrast Ratio	CS1000	1°
Luminance		
Lum Uniformity		
Chromaticity	CS1000	
Response Time	DMS703	-

Note2: Definition of viewing angle range and measurement system.

Viewing angle is measured at the center point of the LCD by CONOSCOPE (DMS703)

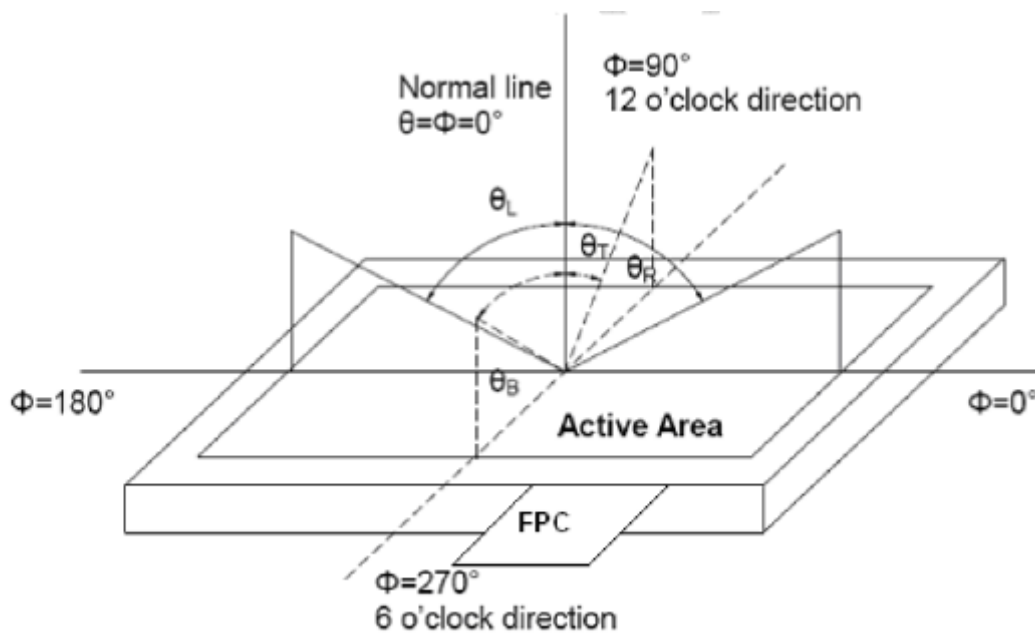

Note3: Definition of contrast ratio

$$\text{Contrast ratio (CR)} = \frac{\text{Luminance measured when LCD is on the "White" state}}{\text{Luminance measured when LCD is on the "Black" state}}$$

“White state ”:The state is that the LCD should drive by V_{white} .

“Black state ”:The state is that the LCD should drive by V_{black} .

V_{white} : To be determined V_{black} : To be determined

Note4:Definition of Response time

The response time is defined as the LCD optical switching time interval between “White”state and “Black” state. Rise time (T_{ON})is the time between photo detector output intensity changed from 90% to 10%.And fall time (T_{OFF})is the time between photo detector output intensity changed from 10% to90%.

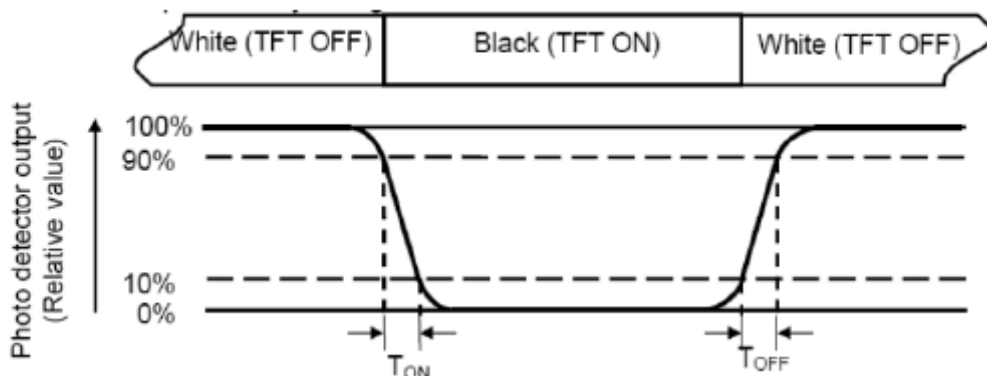

Note5:Definition of color chromaticity (CIE1931)

Color coordinates measured at center point of LCD.

Note6: Definition of Luminance Uniformity

Active area is divided into 9 measuring areas(Refer Fig.2).Every measuring point is placed at the center of each measuring area.

$$\text{Luminance Uniformity (U)} = L_{\text{min}} / L_{\text{max}}$$

L-----Active area length W-----Active area width

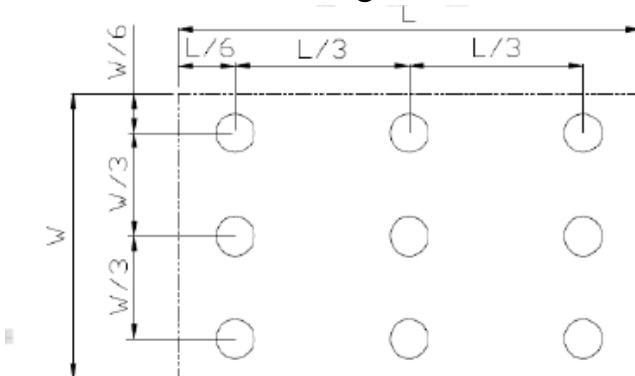

L_{max} : The measured Maximum luminance of all measurement position.

L_{min} : The measured Minimum luminance of all measurement position.

Note7: Definition of luminance: Measure the luminance of white state at center point.

7. Environmental/Reliability Test

No.	Test Item	Test Condition	Inspection after test
1	High Temperature Storage	85±2°C/240 hours	Inspection after 2~4hours storage at room temperature,the sample shall be free from defects: 1.Air bubble in the LCD; 2.Sealleak; 3.Non-display; 4.missing segments; 5.Glass crack; 6.Current Idd is twice higher than initial value.
2	Low Temperature Storage	-40±2°C/240 hours	
3	High Temperature Operating	60±2°C/240 hours	
4	Low Temperature Operating	-20±2°C/240 hours	
5	Temperature Cycle	-40°C~ 25°C~85°C × 10cycles (30min.) (5min.) (30min.)	
6	Damp Proof Test	60°C±5°C×90%RH/240 hours	
7	Vibration Test	Frequency: 10Hz~55Hz~10Hz Amplitude: 1.5mm, X, Y, Z direction for total 3hours (Packing condition)	
8	Dropping test	Drop to the ground from 1m height, one time, every side of carton. (Packing condition)	

Remark:

- 1.The test samples should be applied to only one test item.
- 2.Sample size for each test item is 5~10pcs.
- 3.For Damp Proof Test, Pure water(Resistance> 10MΩ) should be used.
- 4.In case of malfunction defect caused by ESD damage, if it would be recovered to normal state after resetting, it would be judge as a good part.
- 5.Failure Judgment Criterion: Basic Specification, Electrical Characteristic, Mechanical Characteristic, Optical Characteristic.
- 6.Please use automatic switch menu(or roll menu) testing mode when test operating mode.

8. Packing Drawing(TBD)

9. Standard Specifications For Product Quality

9.1. Manner of test:

10.1.1 The test must be under 40W fluorescent light, and the distance of view must be at 30±10cm.

10.1.2 Room temperature 25±5°C Humidity: (60±10)%RH.

9.2. Quality specification

It shall be based on GB2828-87, inspection level II .

	IETM	CHECK LEVEL	AQL
MAJOR (MA)	1.Liquid crystal leakage 2.Wrong polarizer 3.Outside dimension 4. Bright dot、 Dark dot 5. Display abnormal 6. Class crack	II	0.25
MINOR (MI)	1. Spot Defect (Including black spot、 white spot、 pinhole、 foreign particle、 bubbles、 hurt) 2. fragment 3. Line Defect (Including black line、 white line、 cratch) 4. Incision defect 5. Newton's ring 6. Other visual defects	II	1.0

9.3. Definition of area:

10.3.1 I area: viewing area

II area: outside viewing area

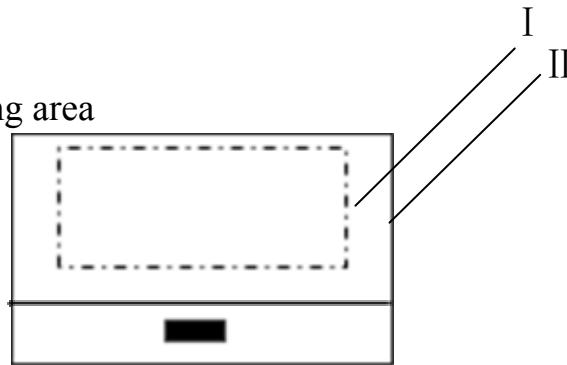

9.4. Standard of appearance test for I area: (unit: mm)

NOTE: Defect ignore for II area .

9.4.1 Bright/Dark Dots explain

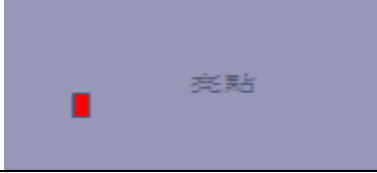
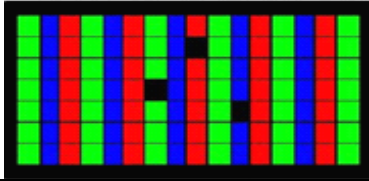
Name	Explain	Definition
Bright dot	<p>Dots appear bright and unchanged in size in which LCD panel is displaying under black pattern</p> 	<p>The definition of dot: The size of a defective dot over 1/2 of single pixel dot is regarded as one defective dot . NOTE: One pixel consists of 3 sub-pixels, including R,G, and B dot.(Sub-pixel = Dot)</p>
Dark dot	<p>Dots appear dark and unchanged in size in which LCD panel is displaying under pure red, green, blue pattern.</p> 	
ADJACENT DOT	Adjacent two sub-pixel are defect (define two dot defect)	

9.4.2 Inspection standard

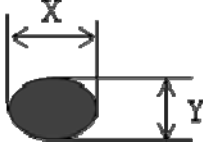
No	Items	Criterion		Checking Manner	Defect Classes
1	Bright/dark dot	Under 6'' (contain 6'')	Bright dot: 2 Dark dot: N≤4 Note: be more than 5mm apart	Checking with eyes	MAJ
		6''-12''	Bright dot: N≤4 Dark dot: N≤5 Total Bright and Dark Dots: N≤8 Note : 1.Two bright dot defects (red, green, blue, and white) should be larger than 15mm; 2.The distance between black dot defects or black and bright dot defects should be more than 5mm apart.		
2	Spot Defect (Including black spot.white spot. Pinhole.foreign particle.bubbles.hurt)  $D=(X+Y)/2$	Under 6'' (contain 6'')	$D \leq 0.1$ Ignore $0.1 < D \leq 0.35$ N≤3 $0.35 < D$ N=0	Checking with eyes	MIN
		6''-12''	$D \leq 0.3$ Ignore $0.3 < D \leq 0.6$ N≤4 $0.6 < D$ N=0		

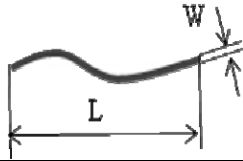
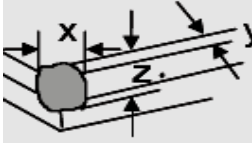
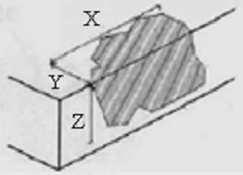
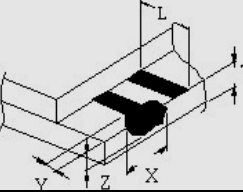
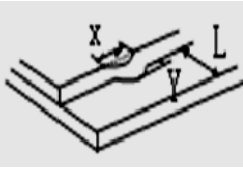
No	Items	Criterion		Checking manner	Defect classes
3	Line Defect (Including black Line.white line. scratch) 	Under 6'' (contain 6'')	$W \leq 0.02$ Ignore $0.02 < W \leq 0.04$ $L \leq 5$ $N \leq 2$ $0.04 < W \leq 0.06$ $L \leq 5$ $N \leq 1$ $W > 0.06$ $N = 0$	Checking with eyes	MIN
		6''-12''	$W \leq 0.07$ Ignore $0.07 < W \leq 0.1$ $L \leq 10$ $N \leq 4$ $W > 0.1$ $N = 0$		
4	Display abnormal	Not allowed		Checking with eyes	MAJ
5	Outside dimension	Accord with drawing		Callipers	MAJ
6	Class crack	Not allowed		Checking with eyes	MAJ
7	Leak	Not allowed		Checking with eyes	MAJ
8	Comer fragment 	$X \leq 3$ $Y \leq 3$ $Z \leq T$ Ignore Note : 1.No hurt identifying .wire.seal 2.T: Glass thickness X: Length Y: Width Z: thickness		Checking with eyes	MIN
9	Side fragment 	$Y \leq 1$ $Z \leq T$ Ignore Note : 1.No hurt identifying .wire.seal 2.T: Glass thickness X: Length Y: Width Z: thickness		Checking with eyes	MIN
	Step fragment 	$Y \leq 1$ and $Y \leq 1/4 L$		Checking with eyes	MIN
9	Incision defect 	$Y \leq 1$ and accord with outside dimension		Checking with eyes	MIN

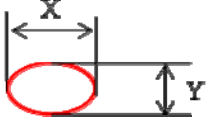
№	Items	Criterion		Checking manner	Defect classes
10	Newton's ring (CTP or Cover board)  $D=(X+Y)/2$	Under 6" (contain 6")	$D \leq 25$ $N \leq 3$ $D > 25$ $N = 0$	Checking with eyes	MIN
6"-12"	$D \leq 70$ $N \leq 5$ $D > 70$ $N = 0$				

10. Precautions for Use of LCD Modules

10.1 Handing Precautions

(1) The display panel is made of glass and polarizer. As glass is fragile. It tends to become or chipped during handling especially on the edges. Please avoid dropping or jarring. Do not subject it to a mechanical shock by dropping it or impact.

(2) If the display panel is damaged and the liquid crystal substance leaks out, be sure not to get any in your mouth. If the substance contacts your skin or clothes, wash it off using soap and water.

(3) Do not apply excessive force to the display surface or the adjoining areas since this may cause the color tone to vary. Do not touch the display with bare hands. This will stain the display area and degraded insulation between terminals (some cosmetics are determined to the polarizer).

(4) The polarizer covering the display surface of the LCD module is soft and easily scratched. Handle this polarizer carefully. Do not touch, push or rub the exposed polarizers with anything harder than an HB pencil lead (glass, tweezers, etc.). Do not put or attach anything on the display area to avoid leaving marks on. Condensation on the surface and contact with terminals due to cold will damage, stain or dirty the polarizer. After products are tested at low temperature they must be warmed up in a container before coming is contacting with room temperature air.

(5) If the display surface becomes contaminated, breathe on the surface and gently wipe it with a soft dry cloth. If it is heavily contaminated, moisten cloth with one of the following solvents

- Isopropyl alcohol
- Ethyl alcohol

Do not scrub hard to avoid damaging the display surface.

(6) Solvents other than those above-mentioned may damage the polarizer.

Especially, do not use the following.

- Water
- Ketone
- Aromatic solvents

Wipe off saliva or water drops immediately, contact with water over a long period of time may cause deformation or color fading. Avoid contacting oil and fats.

(7) Exercise care to minimize corrosion of the electrode. Corrosion of the electrodes is accelerated by water droplets, moisture condensation or a current flow in a high-humidity environment.

(8) Install the LCD Module by using the mounting holes. When mounting the LCD module make sure it is free of twisting, warping and distortion. In particular, do not forcibly pull or bend the I/O cable or the backlight cable.

(9) Do not attempt to disassemble or process the LCD module.

(10) NC terminal should be open. Do not connect anything.

(11) If the logic circuit power is off, do not apply the input signals.

(12) Electro-Static Discharge Control, Since this module uses a CMOS LSI, the same careful attention should be paid to electrostatic discharge as for an ordinary

CMOS IC. To prevent destruction of the elements by static electricity, be careful to maintain an optimum work environment.

- Before remove LCM from its packing case or incorporating it into a set, be sure the module and your body have the same electric potential. Be sure to ground the body when handling the LCD modules.

- Tools required for assembling, such as soldering irons, must be properly grounded. make certain the AC power source for the soldering iron does not leak. When using an electric screwdriver to attach LCM, the screwdriver should be of ground potentiality to minimize as much as possible any transmission of electromagnetic waves produced sparks coming from the commutator of the motor.

- To reduce the amount of static electricity generated, do not conduct assembling and other work under dry conditions. To reduce the generation of static electricity be careful that the air in the work is not too dried. A relative humidity of 50%-60% is recommended. As far as possible make the electric potential of your work clothes and that of the work bench the ground potential.

The LCD module is coated with a film to protect the display surface. Exercise care when peeling off this protective film since static electricity may be generated.

(13) Since LCM has been assembled and adjusted with a high degree of precision, avoid applying excessive shocks to the module or making any alterations or modifications to it.

- Do not alter, modify or change the shape of the tab on the metal frame.
- Do not make extra holes on the printed circuit board, modify its shape or change the positions of components to be attached.
- Do not damage or modify the pattern writing on the printed circuit board.
- Absolutely do not modify the zebra rubber strip (conductive rubber) or heat seal connector.
- Except for soldering the interface, do not make any alterations or modifications with a soldering iron.
- Do not drop, bend or twist LCM.

10.2 Storage Precautions

When storing the LCD modules, the following precaution is necessary.

(1) Store them in a sealed polyethylene bag. If properly sealed, there is no need for the dessicant.

(2) Store them in a dark place. Do not expose to sunlight or fluorescent light, keep the temperature between 0°C and 35°C.

(3) The polarizer surface should not come in contact with any other objects. (We advise you to store them in the container in which they were shipped).

10.3 Others

Liquid crystals solidify under low temperature (below the storage temperature range) leading to defective orientation or the generation of air bubbles (black or white). Air bubbles may also be generated if the module is subject to a low temperature.

If the LCD modules have been operating for a long time showing the same display patterns, the display patterns may remain on the screen as ghost images

and a slight contrast irregularity may also appear. A normal operating status can be regained by suspending use for some time. It should be noted that this phenomenon does not adversely affect performance reliability.

To minimize the performance degradation of the LCD modules resulting from destruction caused by static electricity etc., exercise care to avoid holding the following sections when handling the modules.

- Exposed area of the printed circuit board.
- Terminal electrode sections.

10.4 USING LCD MODULES

Installing LCD Modules

The hole in the printed circuit board is used to fix LCM as shown in the picture below. Attend to the following items when installing the LCM.

(1) Cover the surface with a transparent protective plate to protect the polarizer and LC cell.

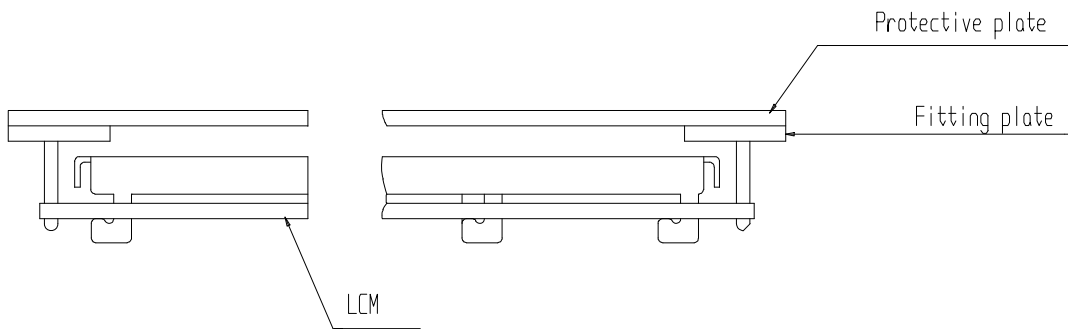

(2) When assembling the LCM into other equipment, the spacer to the bit between the LCM and the fitting plate should have enough height to avoid causing stress to the module surface, refer to the individual specifications for measurements. The measurement tolerance should be ± 0.1 mm.

Precaution for assemble the module with BTB connector:

Please note the position of the male and female connector position, don't assemble or assemble like the method which the following picture shows

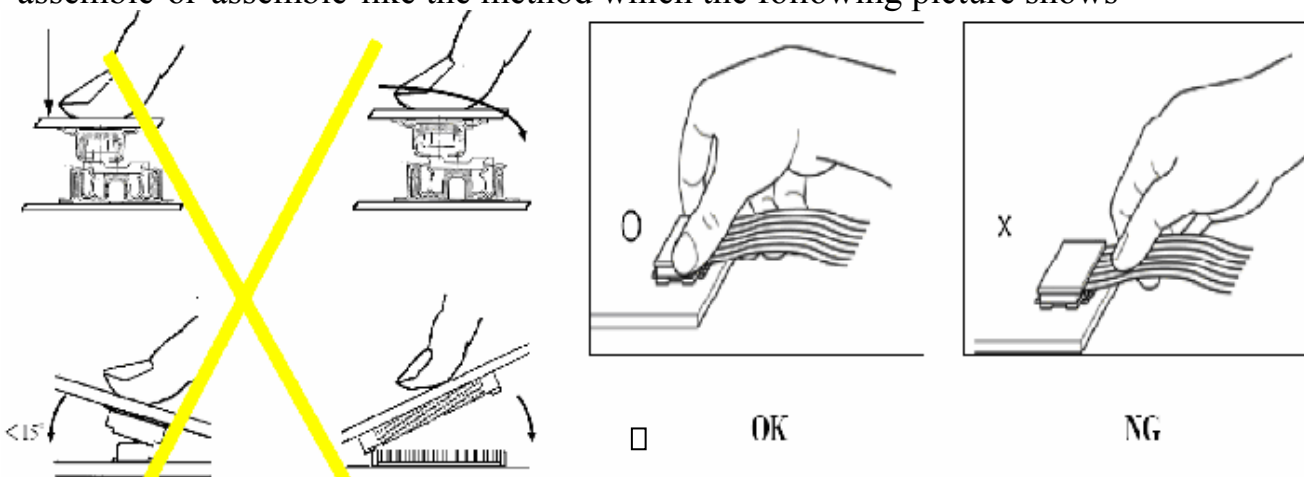

Precaution for soldering to the LCM

	Hand soldering	Machine drag	Machine press soldering
--	----------------	--------------	-------------------------

No ROHS Product	290°C~350°C. Time : 3-5S.	330°C ~350°C. Speed : 4-8mm/s.	300°C~330C. Time : 3-6S. Press: 0.8~1.2Mpa
ROHS Product	340°C~370°C. Time : 3-5S.	350°C ~370°C. Time : 4-8 mm/s.	330°C~360C. Time : 3-6S. Press: 0.8~1.2Mpa

(1) If soldering flux is used, be sure to remove any remaining flux after finishing to soldering operation. (This does not apply in the case of a non-halogen type of flux.) It is recommended that you protect the LCD surface with a cover during soldering to prevent any damage due to flux spatters.

(2) When soldering the electroluminescent panel and PC board, the panel and board should not be detached more than three times. This maximum number is determined by the temperature and time conditions mentioned above, though there may be some variance depending on the temperature of the soldering iron.

(3) When remove the electroluminescent panel from the PC board, be sure the solder has completely melted, the soldered pad on the PC board could be damaged.

Precautions for Operation

(1) It is an indispensable condition to drive LCD's within the specified voltage limit since the higher voltage then the limit cause the shorter LCD life. An electrochemical reaction due to direct current causes LCD's undesirable deterioration, so that the use of direct current drive should be avoided.

(2) Response time will be extremely delayed at lower temperature than the operating temperature range and on the other hand at higher temperature LCD's show dark color in them. However those phenomena do not mean malfunction or out of order with LCD's, Which will come back in the specified operating temperature.

(3) If the display area is pushed hard during operation, the display will become abnormal. However, it will return to normal if it is turned off and then back on.

(4) A slight dew depositing on terminals is a cause for electro-chemical reaction resulting in terminal open circuit. Usage under the maximum operating temperature, 50%RH or less is required.

(5) Input each signal after the positive/negative voltage becomes stable.

(6) Please keep the temperature within specified range for use and storage.

Polarization degradation, bubble generation or polarizer peel-off may occur with high temperature and high humidity.

Safety

(1) It is recommended to crush damaged or unnecessary LCDs into pieces and wash them off with solvents such as acetone and ethanol, which should later be burned.

(2) If any liquid leaks out of a damaged glass cell and comes in contact with the hands, wash off thoroughly with soap and water.

10.5 The disposal of waste

For waste disposal, our recommendations are as follows, please refer to your company

and the relevant provisions of the state laws and regulations of the act accordingly

1. Packing materials disposal for our packaging (carton/PS tray/EPE tray/PET tray)

1) Our company used to recycle and reuse materials, packing materials can be you just

need to transfer to material recycling companies

2. Our scrap module can't be recycled for reuse, so please dispose of,

1) Our scrap module can't be recycled for reuse, products and components are "served" can lead to accidents

2) Our scrap can be transfer to material recycling companies, dismantling, to ensure that scrap in relatively advanced technology products, environmental protection measures of relatively perfect environment for processing.

3. WEEE order must be executed in product scrap.

11. Prior Consult Matter

1.①For YES standard products, we keep the right to change material, process ... for improving the product property without notice on our customer.

②For OEM products, if any change needed which may affect the product property, we will consult with our customer in advance.

2.If you have special requirement about reliability condition, please let us know before you start the test on our samples.

12. Factory

FACTORY NAME: YES OPTOELECTRONICS CO.,LTD

FACTORY ADDRESS: No.288Yueling Road Anshan, Liaoning, P.R.CHINA

FACTORY PHONE: 86-412-5211859 FAX: 86-412-5211729