

# Specification for Colour AMOLED Display module

## 6.01" Colour AMOLED module

Manufacturer	Truly Semiconductors LTD
Part n°	AM060RN90051V0
Ordering n°	AM060RN90051V0
Customer Part n°	n/a
Revision n°	0.3
Issue Date	2017/09/06

### Customer's Approval

Company name	
Printed name	
Job title	
Signature	
Approval Stage:	<p>This product is approved for the following production stage: -</p> <ul style="list-style-type: none"> <li><input type="checkbox"/> Sample / Prototype</li> <li><input type="checkbox"/> Pre-Production</li> <li><input type="checkbox"/> Mass Production</li> </ul>
Approval Date	

Supplied by Anders Electronics plc  
 Manufactured by Truly Semiconductors LTD



# CONTENTS

- SCOPE
- FEATURES
- APPLICATION
- GENERAL INFORMATION
- ABSOLUTE MAXIMUM RATINGS
- ELECTRICAL CHARACTERISTICS
- ELECTRO-OPTICAL CHARACTERISTICS
- INTERFACE DESCRIPTION
- EXTERNAL DIMENSIONS
- RELIABILITY TEST CONDITIONS
- INSPECTION CRITERION
- PRECAUTIONS FOR USING AMOLED MODULES
- PACKING SPECIFICATION
- PRIOR CONSULT MATTER
- FACTORY CONTACT INFORMATION

WRITTEN BY	CHECKED BY	APPROVED BY
XINLAN MA	YW WANG	HU JUNWEN

## ■ SCOPE

This AMOLED module Specification defines general provisions and inspection standard,AMOLED modules Involved are supplied by TRULY (HUIZHOU) SMART DISPLAY LIMITED.In the process of using,if unforeseen problem or unspecified items may occur, we have to negotiate to resolve the issue with the customer certainly.

## ■ FEATURES

- 1) Display color: 16.7M colors(24bits)
- 2) Display format: 6.01 Inch FHD 1080×2160
- 3) Interface: MIPI 4 lanes
- 4) Driver IC: RM69298
- 5) Polarizer: Hard Coating Polarizer
- 6) Gate Output: Only support one-way scan from top (IC on 6 o'clock) to bottom

## ■ APPLICATION

SmartPhone

## ■ GENERAL INFORMATION

Item	Contents	Unit
Display Mode	AMOLED	/
Module Outline (W×H×T)	70.066×142.297×0.769	mm
Glass Outline (W×H×T)	70.066×139.527×0.405	mm
Active area (W×H)	68.256×136.512	mm
Number of Dots	1080×2×2160	/
Diagonal Inch	6.01	inch
Pixel pitch (W×H)	31.6×63.2	um
Glass Thickness	0.2 (LTPS) 0.205 (Encap)	mm

## ■ ABSOLUTE MAXIMUM RATINGS

Parameter	Symbol	Min	Max	Unit
Supply voltage (Display)	VCC	-0.3	5.5	V
	IOVCC	-0.3	5.5	V
	AVDD	-0.3	8.8	V
	ELVDD	-	6.0	V
	ELVSS	-6.5	-	V
Operating temperature	T <sub>OP</sub>	-20	70	°C
Storage temperature	T <sub>ST</sub>	-30	80	°C
Humidity	RH	-	90	%RH

**Note:** Absolute maximum ratings means the product can withstand short-term, NOT more than 120 hours. If the product is a long time to withstand these conditions, the life time would be shorter.

## ■ ELECTRICAL CHARACTERISTICS

Parameter		Symbol	Condition	Min	Typ	Max	Unit
Supply voltage (Display)		VCC		2.5	3.3	3.6	V
		IOVCC		1.65	1.8	1.98	V
		AVDD		4.5	6.4	8	V
		ELVDD	-	4.55	4.6	4.65	V
		ELVSS	-	-4.0	-3.5	-3.0	V
Input voltage	'H' level	V <sub>IH</sub>	VDDI=1.65V~ 1.98V	0.8*IOVCC	-	IOVCC	V
	'L' level	V <sub>IL</sub>		-0.3	-	0.2*IOVCC	V
Output voltage	'H' level	V <sub>OH</sub>	I(OH)=-1mA I(OL)=+1mA	0.8*IOVCC	-	-	V
	'L' level	V <sub>OL</sub>		-0.3	-	0.2*IOVCC	V
Current (Display)	Sleep out mode	I <sub>VCC</sub>	Full white display	-	2	3	mA
		I <sub>IOVCC</sub>		-	32	48	mA
		I <sub>ELVDD/ELVSS</sub>		-	240	360	mA
		I <sub>AVDD</sub>		-	18	27	mA
	Deep Standby mode	I <sub>VCC</sub>		-	-	-	μA
		I <sub>IOVCC</sub>		-	-	-	μA
Frame Frequency		f <sub>FRM</sub>	-	-	60	-	Hz

## ■ ELECTRO-OPTICAL CHARACTERISTICS

Item	Symbol	Condition	Min	Typ	Max	Unit	Remark	Note
Surface Luminance	Lv	θ=0° Ø=0° Ta=25°C	380	430	480	cd/m2	FIG1	1
Contrast ratio	Cr		10000	-	-	---	FIG1	2
Luminance uniformity	δ WHITE		75	-	-	%	FIG1	3
Viewing angle range	θ	Up/Down/Right/Left Cr≥10	88	-	-	deg	FIG2	4
CIE (x, y) chromaticity CIE	Red x	θ=0° Ø=0° Ta=25°C	0.635	0.665	0.695	-		5
	Red y		0.309	0.339	0.369	-		
	Green x		0.169	0.219	0.269	-		
	Green y		0.673	0.723	0.773	-		
	Blue x		0.100	0.140	0.180	-		
	Blue y		0.008	0.048	0.088	-		
	White x		0.275	0.295	0.315	-		
	White y		0.295	0.315	0.335	-		
NTSC ratio	-	-	85	100	-	%		CIE 1931
CrossTalk		25°C	-	-	3	%		6
Gamma	-	θ=0° Ø=0° Ta=25°C V(Gray)=44,68,100,132,164,196,228,252,255	2.0	2.2	2.4	-		
Lifetime	T95	25°C	150	-	-	h		

**Note1.** Surface luminance is the Center Brightness of AMOLED surface with all pixels displaying white. For more information see FIG1.

$$L_v = \text{Surface Luminance (P}_5\text{)}$$

**Note2.** Contrast Ratio(CR) is defined mathematically as For more information see FIG1.

$$\text{Contrast Ratio} = \frac{\text{Average Surface Luminance with all white pixels (P}_1, P_2, P_3, P_4, P_5, P_6, P_7, P_8, P_9\text{)}}{\text{Average Surface Luminance with all black pixels (P}_1, P_2, P_3, P_4, P_5, P_6, P_7, P_8, P_9\text{)}}$$

**Note3.** The uniformity in surface luminance, δWHITE is determined by measuring luminance at each test position 1 through 9, and then dividing the maximum luminance of 9 points luminance by minimum luminance of 9 points luminance. For more information see FIG1.

$$\delta \text{ WHITE} = \frac{\text{Minimum Surface Luminance with all white pixels (P}_1, P_2, P_3, P_4, P_5, P_6, P_7, P_8, P_9\text{)}}{\text{Maximum Surface Luminance with all black pixels (P}_1, P_2, P_3, P_4, P_5, P_6, P_7, P_8, P_9\text{)}}$$

**Note4.** Viewing angle is the angle at which the contrast ratio is greater than 10. The angles are determined for the horizontal or x axis and the vertical or y axis with respect to the z axis which is normal to the LCD surface. For more information see FIG 3.

**Note5.** CIE (x, y) chromaticity, The x,y value is determined by measuring luminance at center position.

**Note6.** Crosstalk.

4% black or white window , 117 gray

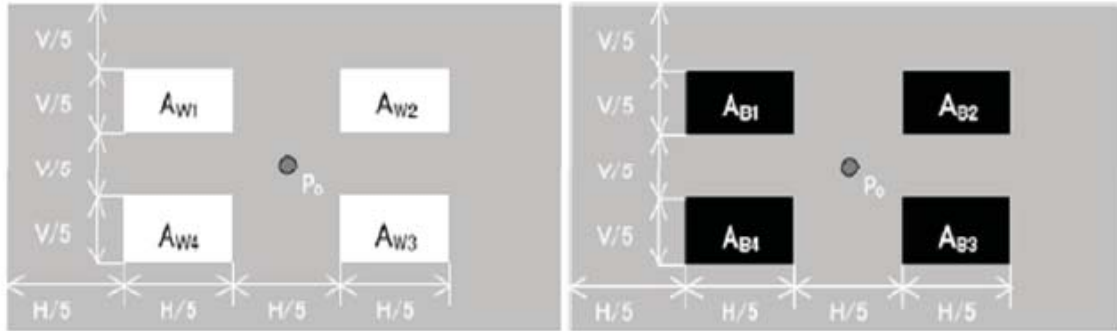

(a)  $L_{W\_OFF}$ ,  $L_{B\_OFF}$  measuring pattern

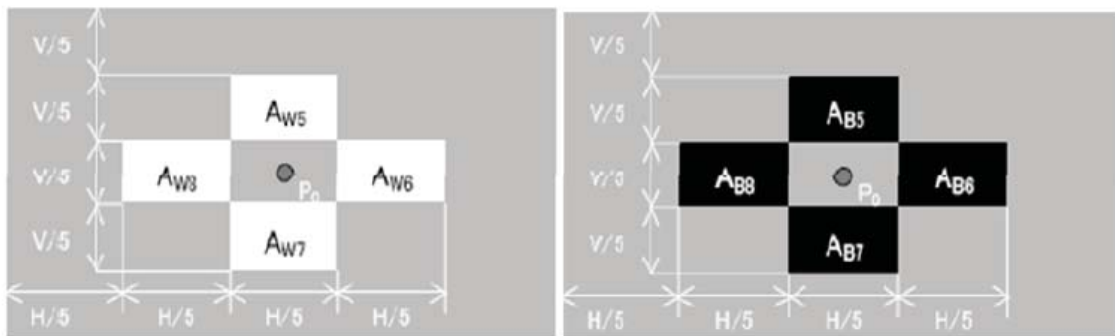

(b)  $L_{W\_ON}$ ,  $L_{B\_ON}$  measuring pattern

$$L_{W\_OFF} = \frac{L_{w1} + L_{w2} + L_{w3} + L_{w4}}{4}$$

$$L_{B\_OFF} = \frac{L_{B1} + L_{B2} + L_{B3} + L_{B4}}{4}$$

$$CT = \frac{|L_{W_{i\_ON}} - L_{W\_OFF}|}{L_{W\_OFF}} \times 100\% (i=5 \text{ to } 8)$$

For white windows  $A_{wi}$  ( $i = 5$  to  $8$ ), and

$$CT = \frac{|L_{B_{i\_ON}} - L_{B\_OFF}|}{L_{B\_OFF}} \times 100\% (i=5 \text{ to } 8)$$

For black windows  $A_{Bi}$  ( $i = 5$  to  $8$ ).

The maximum cross-talk value shall be noted in the measurement report.

FIG1 Measuring method for Contrast ratio,surface luminance, Luminance uniformity

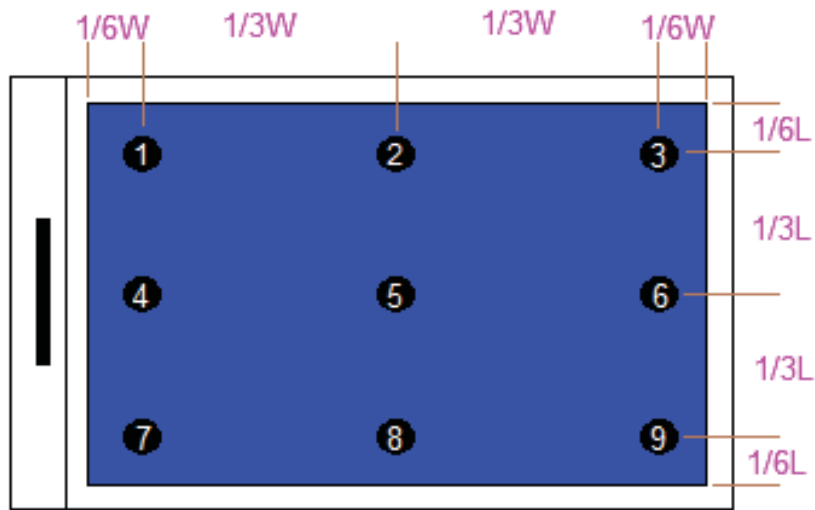
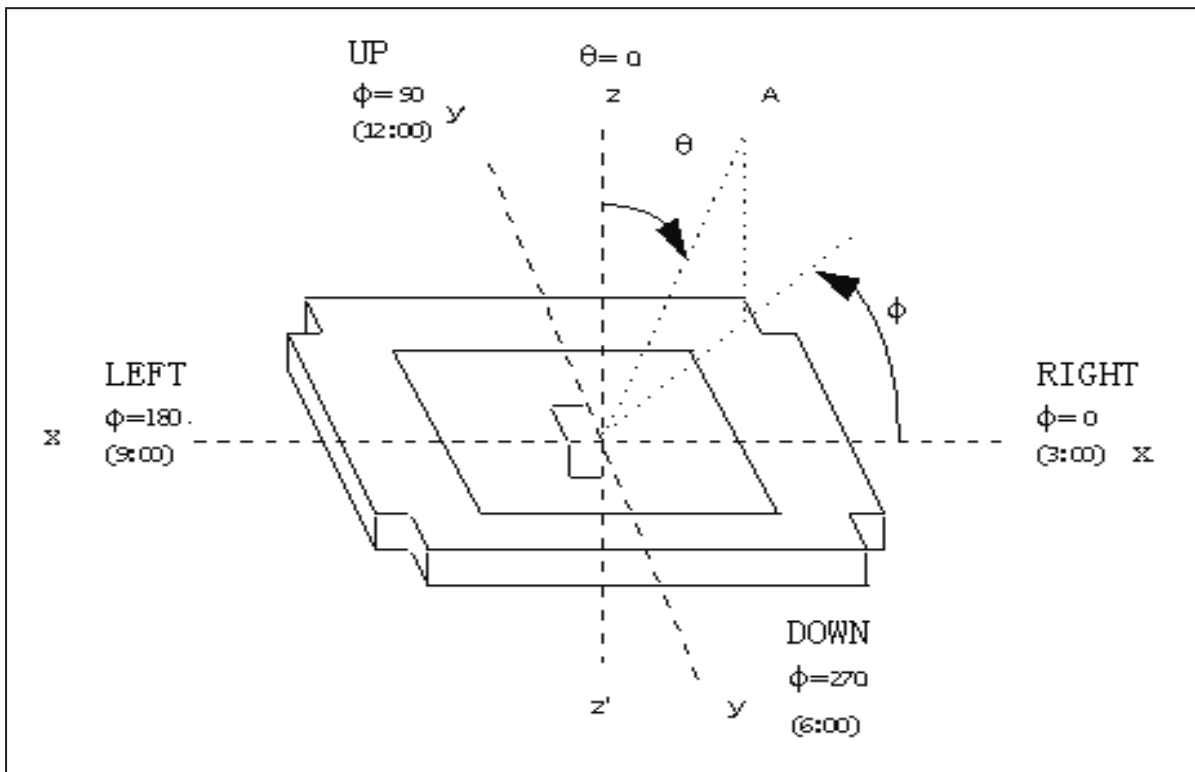

FIG2 The definition of viewing angle





## ■ INTERFACE DESCRIPTION

Interface NO.	Symbol	I/O or Connected to	Description	When not in use
1	ELVDD	Power	Power supply for pixel circuit.	
2	ELVSS	Power	Power supply for pixel circuit.	
3	ELVDD	Power	Power supply for pixel circuit.	
4	ELVSS	Power	Power supply for pixel circuit.	
5	ELVDD	Power	Power supply for pixel circuit.	
6	ELVSS	Power	Power supply for pixel circuit.	
7	AVDD	Power	Power supply for Analog system. Ground.	
8	GND	Power	Power supply for interface system except MIPI interface	
9	VCC	Power	Power supply for Analog circuit VDDA, VDDDB and VDDR should be the same input voltage level	
10	D3N	I	MIPI interface.	Connected to GND
11	IOVCC	Power	Power supply for interface system except MIPI interface Ground.	
12	D3P	I	MIPI interface.	Connected to GND
13	MTP_PWR	Power	MTP programming power supply pin. (8V typical) Must be left open or connected to DVSS in normal condition.	Left open or connected to GND
14	GND	Power	Power supply for interface system except MIPI interface	
15	RESET	I	This signal will reset the device and must be applied to properly initialize the chip. Signal is active low.	
16	D0N	I/O	MIPI interface.	Connected to GND
17	OLED_EN	O	Power IC enable control pin (Note: "H" = VDDI level, "L" = VSSI level.)	
18	D0P	I/O	MIPI interface.	Connected to GND
19	SWIRE	O	Swire protocol setting pin (Note: "H" = VDDI level, "L" = VSSI level.)	
20	GND	Power	Power supply for interface system except MIPI interface	
21	TE	O	Tearing effect output pin to synchronize MCU to frame writing, activated by S/W command. When this pin is not activated, this pin is output low. If not used, please open this pin.	Open
22	CKN	I	MIPI interface.	Connected to GND
23	PCD/DISS	I	Disable SPI pins. "H", Demura SPI pin output HiZ 'L', Demura SPI pin can access flash	
24	CKP	I	MIPI interface.	Connected to GND
25	TSP_SDA	I	Touch I2C data	
26	GND	Power	Power supply for interface system except MIPI interface	
27	TSP_SCL	I	Touch I2C data	
28	D1N	I	MIPI interface.	Connected to GND
29	TSP_RESET	I	TSP Reset signal. Active low.	
30	D1P	I	MIPI interface.	Connected to GND

31	TSP_INT	I	Touch State change interrupt	
32	GND	Power	Power supply for interface system except MIPI interface	
33	SPDI		SPI(Master) DI	
34	D2N	I	MIPI interface.	Connected to GND
35	SPDO		SPI(Master) DO	
36	D2P	I	MIPI interface.	Connected to GND
37	SPCS		SPI(Master) CS	
38	GND	Power	Power supply for interface system except MIPI interface	
39	SPCK		SPI(Master) CLK	
40	TSP_3.3V	Power	TP Power Supply	

### Module Block Diagram

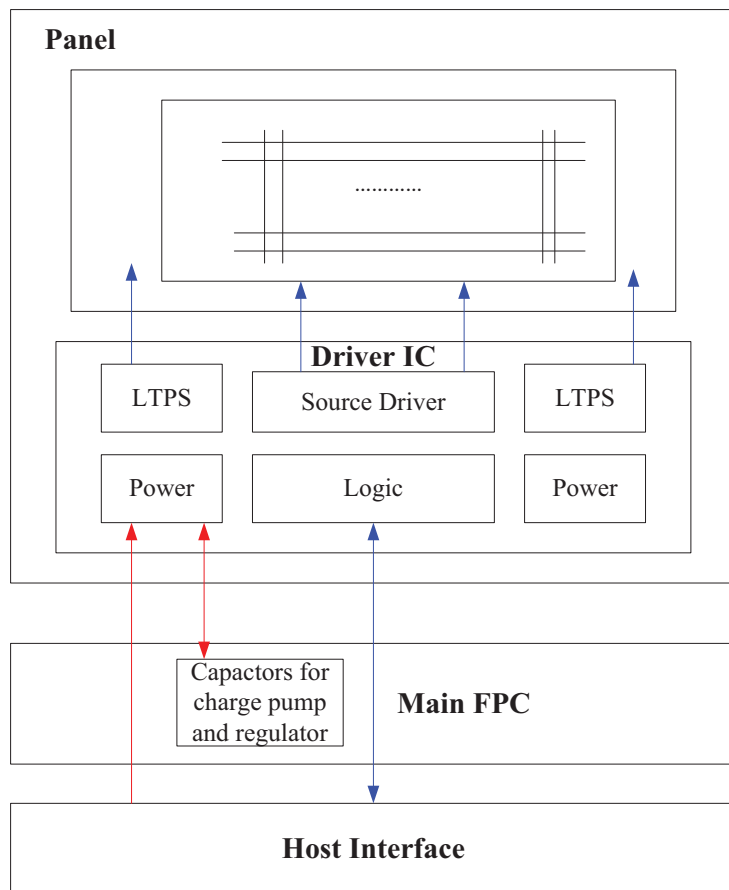

Note:  
 Red line stand for Power  
 Bule line stand for Signal

### Recommended Operating Sequence

Note: 1.VDDI(IOVCC); 2. VCI(VCC); 3. RSTB(RESET)

Power on sequence

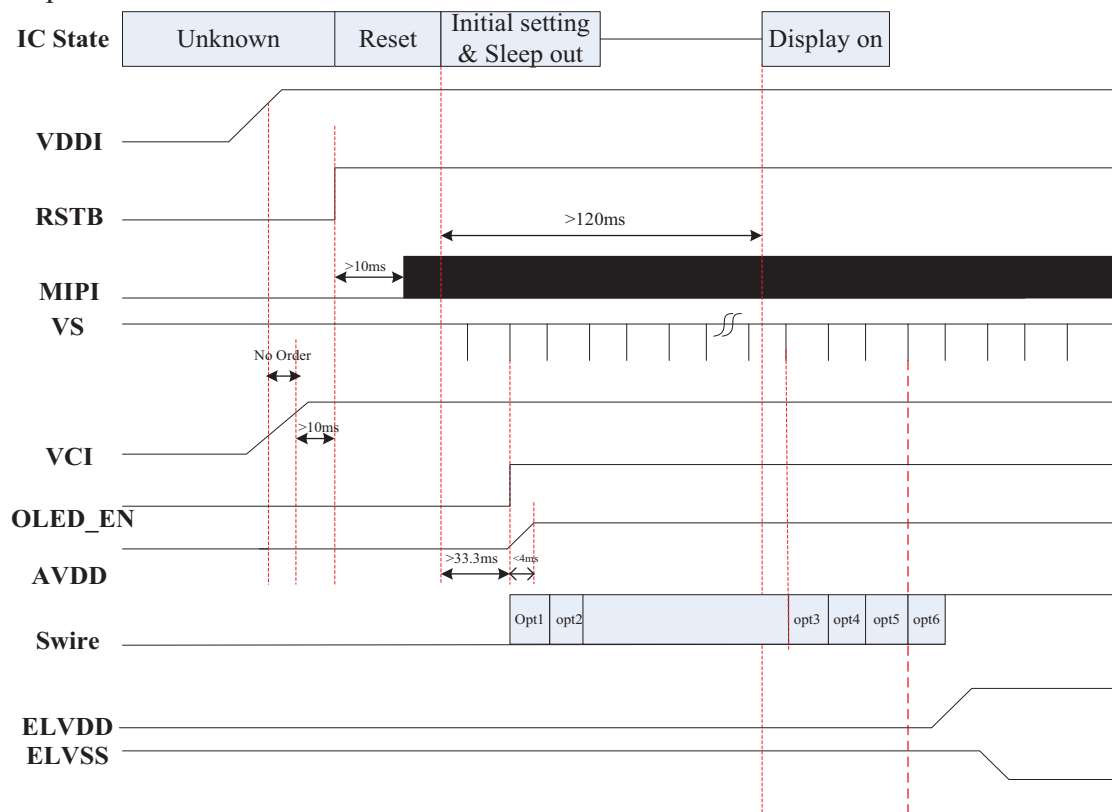

Power off sequence

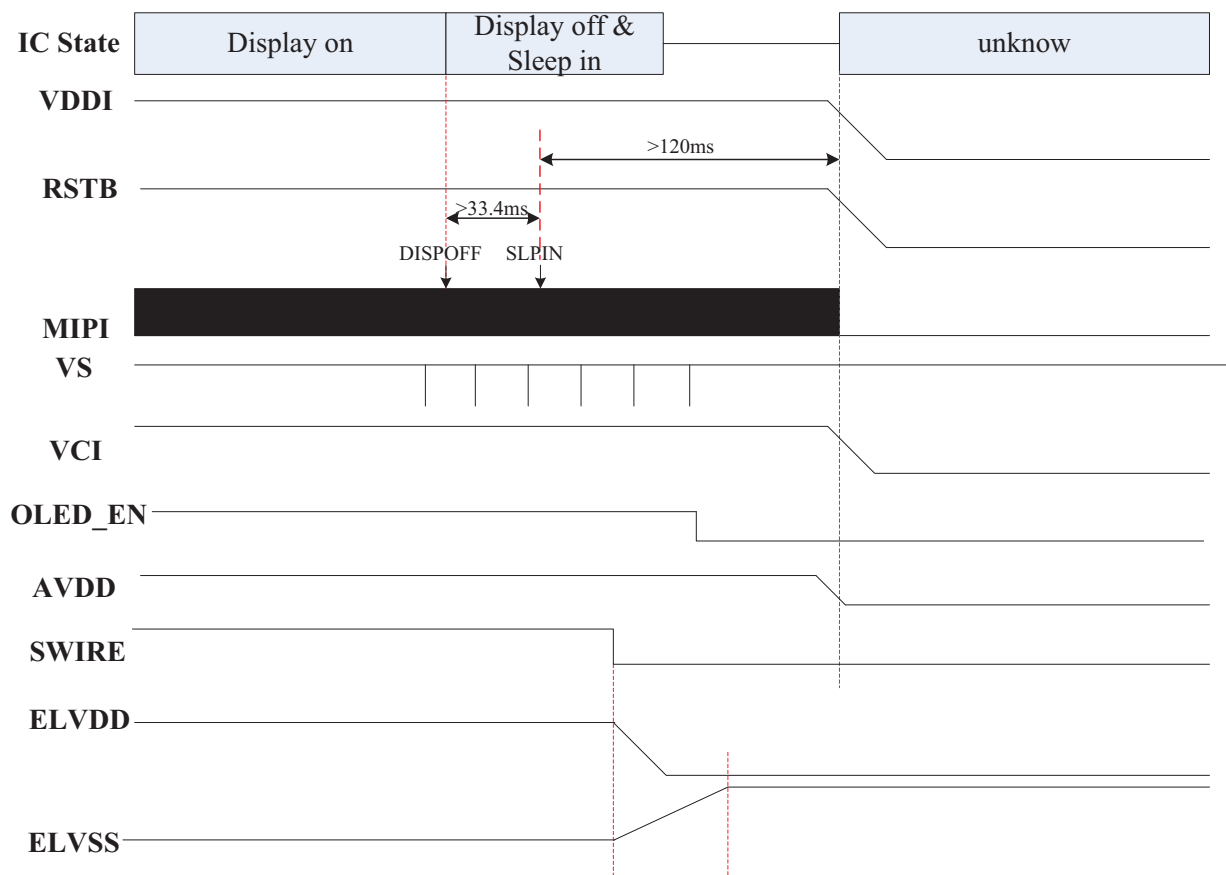

Reset Timing

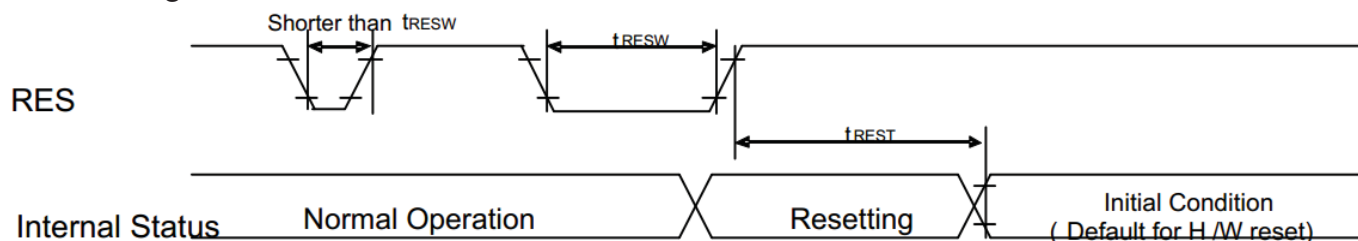

Reset input timing:

VDDI=1.65 to 3.3V, VCI=2.5 to 4.8V, AGND=DGND=0V, Ta=-20 to 60°C

Symbol	Parameter	Related Pins	MIN	TYP	MAX	Note	Unit
tRESW	Reset low pulse width	RESX	10	-	-	-	Us
tREST	Reset complete time	-	-	-	5	When reset applied during Sleep in mode	ms
		-	-	-	120	When reset applied during Sleep out mode	ms

EXTERNAL DIMENSIONS

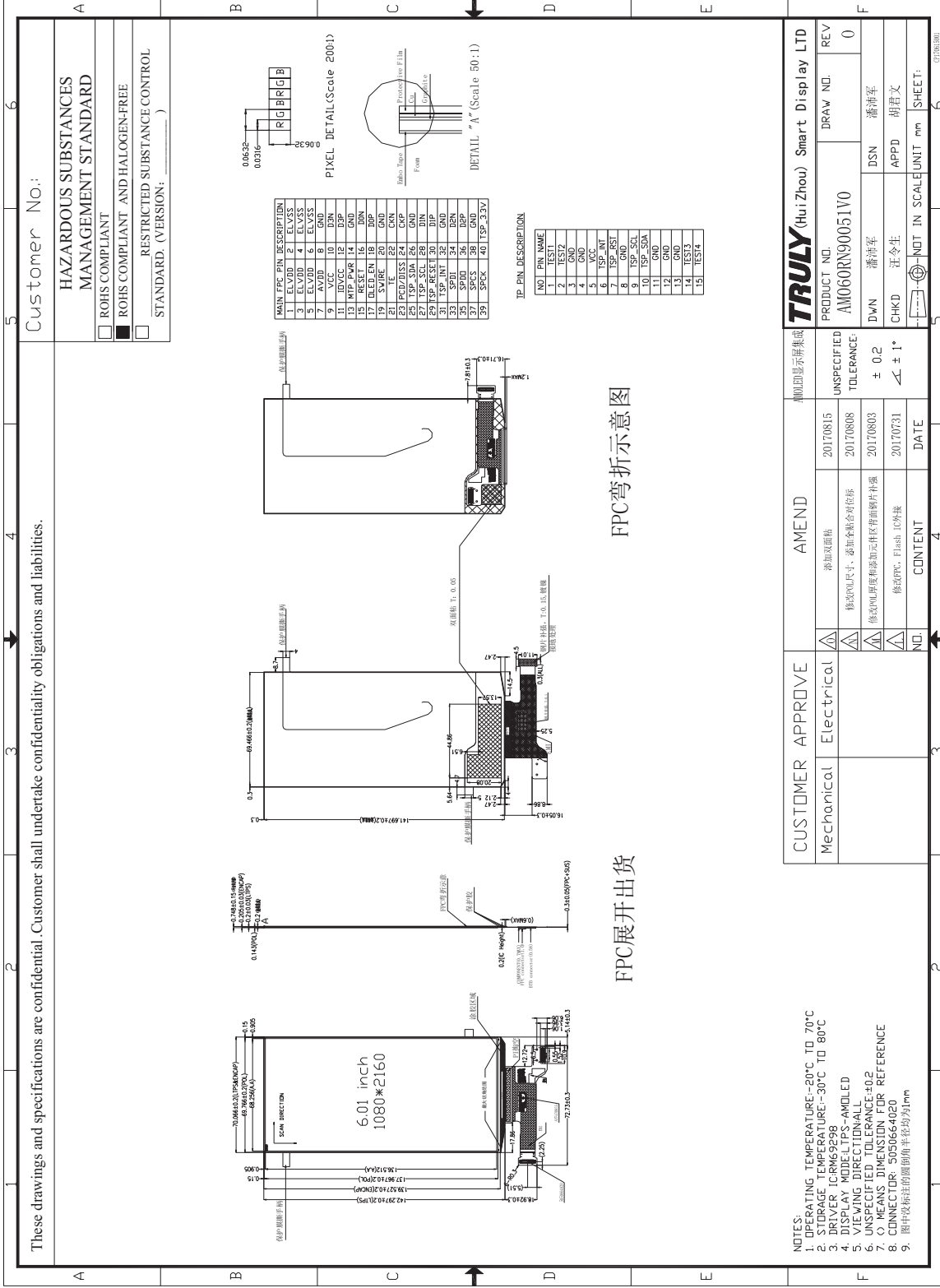

## ■ RELIABILITY TEST CONDITIONS

No.	Test Item	Test Condition	Qty	Inspection after test
1	High Temperature Storage	80°C±2°C/120 hours	5	Inspection after 2 hours storage at room temperature, the sample shall be free from defects: 1. remarkable deterioration of No clearly visible defects or display quality. However, any polarizer's deteriorations by the high temperature/High humidity Storage test and the High temperature/High humidity Operation test are permitted. 2. No function-related abnormalities. 3. Optical criteria : .White $\Delta u'v' \leq 0.02$ 4. No visible defects .(optical / mechanical) . 5. No function-related abnormalities
2	Low Temperature Storage	-30°C±2°C/120 hours	5	
3	High Temperature Operating	70°C±2°C/120 hours	5	
4	Low Temperature Operating	-20°C±2°C/120 hours	5	
5	Temperature Cycle storage	-30°C±2°C~25~80°C±2°C×30cycles (30min.) (5min.) (30min.)	5	
6	High Temperature Humidity Storage	60°C±5°C×90%RH/120 hours	5	
7	ESD test	Voltage:±8KV R: 330Ω C: 150pF Air discharge, 10time	5	
8	Vibration Test	Frequency: 10Hz~55Hz~10Hz Amplitude: 1.5mm, X, Y, Z direction for total 3hours (Packing condition)	5	
9	Dropping test	Drop to the ground from 75cm height, one time, every side of carton. (Packing condition)	5	

**Remark:**

1. The test samples should be applied to only one test item.
2. For Damp Proof Test, Pure water (Resistance > 10MΩ) should be used.
3. In case of malfunction defect caused by ESD damage, if it would be recovered to normal state after resetting, it would be judged as a good part.
4. Failure Judgment Criterion: Basic Specification, Electrical Characteristic, Mechanical Characteristic, Optical Characteristic.

## ■INSPECTION CRITERION

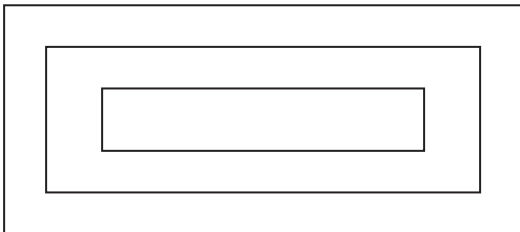
<b>TRULY</b> ® OUTGOING QUALITY STANDARD		Edition: A	
TITLE:FUNCTIONAL TEST & INSPECTION CRITERIA		AMOLEDProduct	
This specification is made to be used as the standard acceptance/rejection criteria for AMOLED Product			
<b>1. Sample plan</b>			
Sampling plan according to GB/T2828.1-2003/ISO 2859-1: 1999 and ANSI/ASQC Z1.4-1993, normal level 2 and based on:			
Major defect: AQL 0.65			
Minor defect: AQL 1.5			
<b>2. Inspection condition</b>			
Viewing distance for cosmetic inspection is about 30cm with bare eyes, and under an environment of 20~40W light intensity, all directions for inspecting the sample should be within 45° against perpendicular line.			
<b>3. Definition of inspection zone in AMOLED</b>			
			
Zone A: character/Digit area			
Zone B: viewing area except Zone A (ZoneA+ZoneB=minimum Viewing area)			
Zone C: Outside viewing area (invisible area after assembly in customer's product)			
Fig.1 Inspection zones in an LCD.			
Note: As a general rule, visual defects in Zone C are permissible, when it is no trouble for quality and assembly of customer's product.			
<b>4. Inspection standards</b>			
<b>4.1 Major Defect</b>			
Item No	Items to be inspected	Inspection Standard	Classification of defects
4.1.1	All functional defects	1) No display 2) Display abnormally 3) Missing vertical, horizontal segment 4) Short circuit	Major
4.1.2	Missing	Missing component	
4.1.3	Outline dimension	Overall outline dimension beyond the drawing is not allowed.	
<b>4.2 Cosmetic Defect</b>			
Item No	Items to be inspected	Inspection Standard	Classification of defects

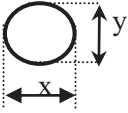
For dark/white spot, size $\Phi$ is defined as:						
$\Phi = \frac{(x+y)}{2}$						
4.2.1	Clear Spots Black and white Spot defect Pinhole, Foreign Particle, Dirt under polarizer	Zone		Acceptable Qty		
		Size(mm)		A	B	C
		$\Phi \leq 0.1$		Ignore		
		$0.10 < \Phi \leq 0.20$		2		
		$0.20 < \Phi \leq 0.25$		1		
$0.25 < \Phi$		0				
					Minor	
4.2.2	Dim Spots Circle shaped and dim edged defects	Zone		Acceptable Qty		
		Size(mm)		A	B	C
		$\Phi \leq 0.2$		Ignore		
		$0.20 < \Phi \leq 0.40$		2		
		$0.40 < \Phi \leq 0.60$		1		
$0.60 < \Phi$		0				
					Minor	
4.2.3	Line defect Black line, White line, Foreign material under polarizer	Size(mm)		Acceptable Qty		
		L(Length)	W(Width)	Zone		
				A	B	C
		Ignore	$W \leq 0.02$	Ignore		
		$L \leq 5.0$	$0.02 < W \leq 0.03$	2		
		$L \leq 3.0$	$0.03 < W \leq 0.05$	1		
	$0.05 < W$	Define as spot defect				
					Minor	

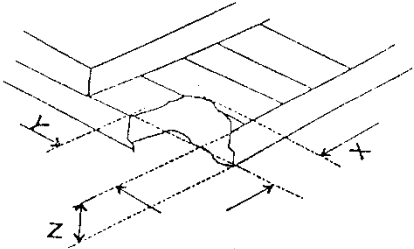
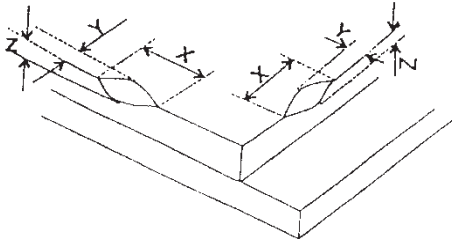
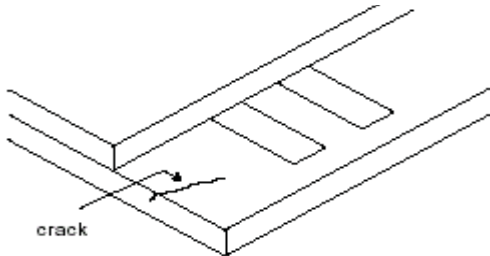

4.2.4	Polarizer scratch	<p>If the Polarizer scratch can be seen after mobile phone cover assembling or in the operating condition, judge by the line defect of 4.2.2.</p> <p>If the Polarizer scratch can be seen only in non-operating condition or some special angle, judge by the following.</p> <table border="1" data-bbox="408 349 1126 792"> <thead> <tr> <th colspan="2">Size(mm)</th> <th colspan="3">Acceptable Qty</th> </tr> <tr> <th rowspan="2">L(Length)</th> <th rowspan="2">W(Width)</th> <th colspan="3">Zone</th> </tr> <tr> <th>A</th> <th>B</th> <th>C</th> </tr> </thead> <tbody> <tr> <td>Ignore</td> <td><math>W \leq 0.03</math></td> <td colspan="3">Ignore</td> </tr> <tr> <td><math>5.0 &lt; L \leq 10.0</math></td> <td><math>0.03 &lt; W \leq 0.05</math></td> <td colspan="3">2</td> </tr> <tr> <td><math>L \leq 5.0</math></td> <td><math>0.05 &lt; W \leq 0.08</math></td> <td colspan="3">1</td> </tr> <tr> <td></td> <td><math>0.08 &lt; W</math></td> <td colspan="3">0</td> </tr> </tbody> </table>	Size(mm)		Acceptable Qty			L(Length)	W(Width)	Zone			A	B	C	Ignore	$W \leq 0.03$	Ignore			$5.0 < L \leq 10.0$	$0.03 < W \leq 0.05$	2			$L \leq 5.0$	$0.05 < W \leq 0.08$	1				$0.08 < W$	0			Minor	
Size(mm)		Acceptable Qty																																			
L(Length)	W(Width)	Zone																																			
		A	B	C																																	
Ignore	$W \leq 0.03$	Ignore																																			
$5.0 < L \leq 10.0$	$0.03 < W \leq 0.05$	2																																			
$L \leq 5.0$	$0.05 < W \leq 0.08$	1																																			
	$0.08 < W$	0																																			
4.2.5	PolarizeAir bubble	<p>Air bubbles between glass &amp; polarizer</p> <table border="1" data-bbox="408 887 1126 1249"> <thead> <tr> <th rowspan="2">Zone Size(mm)</th> <th colspan="3">Acceptable Qty</th> </tr> <tr> <th>A</th> <th>B</th> <th>C</th> </tr> </thead> <tbody> <tr> <td><math>\Phi \leq 0.2</math></td> <td colspan="3">Ignore</td> </tr> <tr> <td><math>0.20 &lt; \Phi \leq 0.30</math></td> <td colspan="3">2</td> </tr> <tr> <td><math>0.30 &lt; \Phi \leq 0.50</math></td> <td colspan="3">1</td> </tr> <tr> <td><math>0.50 &lt; \Phi</math></td> <td colspan="3">0</td> </tr> </tbody> </table>	Zone Size(mm)	Acceptable Qty			A	B	C	$\Phi \leq 0.2$	Ignore			$0.20 < \Phi \leq 0.30$	2			$0.30 < \Phi \leq 0.50$	1			$0.50 < \Phi$	0			Minor											
Zone Size(mm)	Acceptable Qty																																				
	A	B	C																																		
$\Phi \leq 0.2$	Ignore																																				
$0.20 < \Phi \leq 0.30$	2																																				
$0.30 < \Phi \leq 0.50$	1																																				
$0.50 < \Phi$	0																																				

4.2.6	Glass defect	<p>(i) Chips on corner</p>  <table border="1" data-bbox="464 535 1099 631"> <thead> <tr> <th>X</th> <th>Y</th> <th>Z</th> </tr> </thead> <tbody> <tr> <td><math>\leq 2.0</math></td> <td><math>\leq S</math></td> <td>Disregard</td> </tr> </tbody> </table> <p>Notes: S=contact pad length Chips on the corner of terminal shall not be allowed to extend into the ITO pad or expose perimeter seal.</p>	X	Y	Z	$\leq 2.0$	$\leq S$	Disregard	Minor
		X	Y	Z					
		$\leq 2.0$	$\leq S$	Disregard					
<p>(ii) Usual surface cracks</p>  <table border="1" data-bbox="443 1077 1121 1173"> <thead> <tr> <th>X</th> <th>Y</th> <th>Z</th> </tr> </thead> <tbody> <tr> <td><math>\leq 5.0</math></td> <td>&lt;Inner border line of the seal</td> <td>Disregard</td> </tr> </tbody> </table>	X	Y	Z	$\leq 5.0$	<Inner border line of the seal	Disregard	Minor		
X	Y	Z							
$\leq 5.0$	<Inner border line of the seal	Disregard							
<p>(iii) Crack</p> <p>Cracks tend to break are not allowed.</p> 	Major								
4.2.7	ELA Stain	Follow the limit sample which is fixed with a customer. (Judgment condition : 127Gray) ----- note 1	Minor						
4.2.8	Uneven color stain	Follow the limit sample which is fixed with a customer. (Judgment condition : full white pattern)	Minor						

[note1] ELA(Excimer Laser Annealing) stain

: Vertical or horizontal dim lines which are caused by laser annealing process.

## ■PRECAUTIONS FOR USING AMOLED MODULES

### Handing Precautions

- 1 The display panel is made of glass and polarizer. As glass is fragile. It tends to become or chipped during handling especially on the edges. Please avoid dropping or jarring. Do not subject it to a mechanical shock by dropping it or impact.
- 2 Do not apply excessive force to the display surface or the adjoining areas since this may cause the color tone to vary. Do not touch the display with bare hands. This will stain the display area and degraded insulation between terminals (some cosmetics are determined to the polarizer).
- 3 The polarizer covering the display surface is soft and easily scratched. Handle this polarizer carefully. Do not touch, push or rub the exposed polarizers with anything harder than an HB pencil lead (glass, tweezers, etc.). Do not put or attach anything on the display area to avoid leaving marks on it. Condensation on the surface and contact with terminals due to cold will damage, stain or dirty the polarizer. After products are tested at low temperature they must be warmed up in a container before coming in to contact with room temperature air.
- 4 If the display surface becomes contaminated, breathe on the surface and gently wipe it with a soft dry cloth. If it is heavily contaminated, moisten cloth with one of the following solvents
  - Isopropyl alcohol
  - Ethyl alcoholDo not scrub hard to avoid damaging the display surface.
- 5 Solvents other than those above-mentioned may damage the polarizer. Especially, do not use the following.
  - Water
  - Ketone
  - Aromatic solventsWipe off saliva or water drops immediately, contact with water over a long period of time may cause deformation or color fading. Avoid contact with oil and fats.
- 6 Exercise care to minimize corrosion of the electrode. Corrosion of the electrodes is accelerated by water droplets, moisture condensation or a current flow in a high-humidity environment.
- 7 Do not attempt to disassemble or process the AMOLED module.
- 8 NC terminal should be open. Do not connect anything.
- 9 If the logic circuit power is off, do not apply the input signals.
- 10 Electro-Static Discharge Control, Since this module uses a CMOS LSI, the same careful attention should be paid to electrostatic discharge as for an ordinary CMOS IC. To prevent destruction of the elements by static electricity, be careful to maintain an optimum work environment.
  - Before removing AMOLED from its packing case or incorporating it into a set, be sure the module and your body have the same electric potential. Be sure to ground the body when handling the AMOLED modules.
  - Tools required for assembling, such as soldering irons, must be properly grounded. Make certain the AC power source for the soldering iron does not leak. When using an electric screwdriver to attach AMOLED modules, the screwdriver should be of ground potentiality to minimize as much as possible any transmission of electromagnetic waves produced sparks coming from the commutator of the motor.
  - To reduce the amount of static electricity generated, do not conduct assembling and other work under dry conditions. To reduce the generation of static electricity be careful that the air in the work is not too dry. A relative humidity of 50%-60% is recommended. As far as possible make the electric potential of your work clothes and that of the work bench the ground potential.
  - The AMOLED module is coated with a film to protect the display surface. Exercise care when peeling off this protective film since static electricity may be generated.
- 11 Since AMOLED has been assembled and adjusted with a high degree of precision, avoid applying excessive shocks to the module or making any alterations or modifications to it.

- 
- Do not alter, modify or change the shape of the tab on the metal frame.
  - Do not make extra holes on the printed circuit board, modify its shape or change the positions of components to be attached.
  - Do not damage or modify the pattern writing on the printed circuit board.
  - Absolutely do not modify the zebra rubber strip (conductive rubber) or heat seal connector.
  - Except for soldering the interface, do not make any alterations or modifications with a soldering iron.
  - Do not drop, bend or twist the AMOLED.

### Handling precaution for AMOLED

- 1 AMOLED is easy to be damaged. Please note below and be careful for handling.
- 2 Correct handling:
- 3 Incorrect handling:

### Storage Precautions

- 1 When storing the AMOLED modules, the following precaution are necessary.
  - 1) Store them in a sealed polyethylene bag. If properly sealed, there is no need for the desiccant.
  - 2) Store them in a dark place. Do not expose to sunlight or fluorescent light, keep the temperature between 0°C and 35°C, and keep the relative humidity between 40%RH and 60%RH.
  - 3) The polarizer surface should not come in contact with any other objects (We advise you to store them in the anti-static electricity container in which they were shipped).
- 2 Transportation Precautions
  - 1) During shipment, please handle with care. The packaging bag can not be broken, step on trap. Packaging Carton layer height can not be over two meters.
  - 2) The transportation process should pay attention to the waterproof and moisture-proof measures. Product can not be watering. Ethylene sealed bags can not be unsealed.
- 3 Others
  - 1) To minimize the performance degradation of the AMOLED modules resulting from destruction caused by static electricity etc., exercise care to avoid holding the following sections when handling the modules.
    - a) - Exposed area of the printed circuit board.
    - b) - Terminal electrode sections.

### USING AMOLED MODULES

#### 1 Installing AMOLED Modules

The hole in the printed circuit board is used to fix AMOLED as shown in the picture below. Attend to the following items when installing the AMOLED.

- 1) Cover the surface with a transparent protective plate to protect the polarizer.
  - 2) When assembling the AMOLED into other equipment, the spacer to the bit between the AMOLED and the fitting plate should have enough height to avoid causing stress to the module surface, refer to the individual specifications for measurements. The measurement tolerance should be  $\pm 0.1$ mm.
- #### 2 Precaution for assemble the module with BTB connector:

Please note the position of the male and female connector position, don't assemble or assemble like the method which the following picture shows

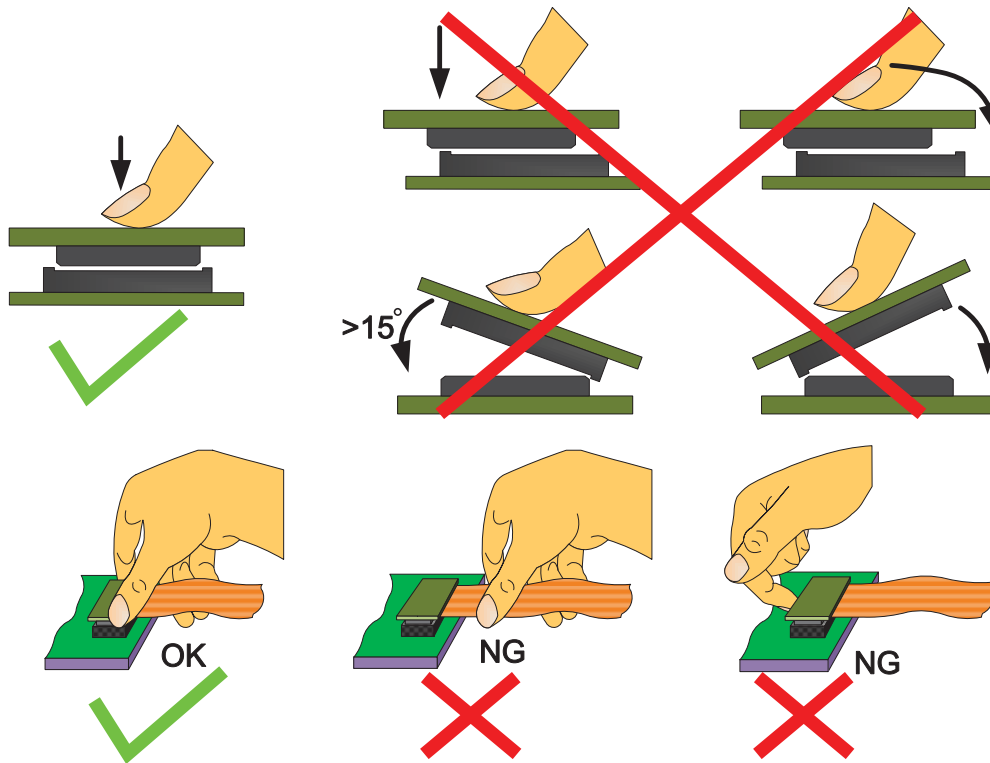

3 Precaution for soldering the AMOLED

	Manual soldering	Machine drag soldering	Machine press soldering
No RoHS Product	290°C ~350°C. Time : 3-5S.	330°C ~350°C. Speed : 4-8 mm/s.	300°C ~330°C. Time : 3-6S. Press: 0.8~1.2Mpa
RoHS Product	340°C ~370°C. Time : 3-5S.	350°C ~370°C. Time : 4-8 mm/s.	330°C ~360°C. Time : 3-6S. Press: 0.8~1.2Mpa

- 1) If soldering flux is used, be sure to remove any remaining flux after finishing to soldering operation (This does not apply in the case of a non-halogen type of flux). It is recommended that you protect the AMOLED surface with a cover during soldering to prevent any damage due to flux spatters.
- 2) When soldering the PC board, the board should not be detached more than three times. This maximum number is determined by the temperature and time conditions mentioned above, though there may be some variance depending on the temperature of the soldering iron.

4 Precautions for Operation

- 1) If the display area is pushed hard during operation, the display will become abnormal. However, it will return to normal if it is turned off and then back on.
- 2) A slight dew depositing on terminals is a cause for electro-chemical reaction resulting in terminal open circuit. Usage under the maximum operating temperature, 50%RH or less is required.
- 3) Input logic voltage before apply analog high voltage such as AMOLED driving voltage when power on. Remove analog high voltage before logic voltage when power off the module. Input each signal after the positive/negative voltage becomes stable.
- 4) Please keep the temperature within the specified range for use and storage. Polarization degradation, bubble generation or polarizer peel-off may occur with high temperature and high humidity.

5 Safety

- 1) It is recommended to crush damaged or unnecessary AMOLEDs into pieces and wash them off with solvents such as acetone and ethanol, which should later be burned.

6 Limited Warranty

Unless agreed between TRULY and the customer, TRULY will replace or repair any of its AMOLED modules

which are found to be functionally defective when inspected in accordance with TRULY AMOLED acceptance standards (copies available upon request) for a period of one year from date of production. Cosmetic/visual defects must be returned to TRULY within 90 days of shipment. Confirmation of such date shall be based on data code on product. The warranty liability of TRULY limited to repair and/or replace on the terms set forth above. TRULY will not be responsible for any subsequent or consequential events.

7 Return AMOLED under warranty

- 1) No warranty can be granted if the precautions stated above have been disregarded. The typical examples of violations are :
  - a) - Broken AMOLED glass.
  - b) - PCB eyelet is damaged or modified.
  - c) -PCB conductors damaged.
  - d) - Circuit modified in any way, including addition of components.
  - e) - PCB tampered with by grinding, engraving or painting varnish.
  - f) - Soldering to or modifying the bezel in any manner.
- 2) Module repairs will be invoiced to the customer upon mutual agreement. Modules must be returned with sufficient description of the failures or defects. Any connectors or cable installed by the customer must be removed completely without damaging the PCB eyelet, conductors and terminals.

## ■ PACKING SPECIFICATION

Please consult our technical department for detail information.

## ■ PRIOR CONSULT MATTER

- 1 For Truly standard products, we keep the right to change material, process ... for improving the product property without prior notice to our customer.
- 2 If you have special requirement about reliability condition, please let us know before you start the test on our samples.

## ■ FACTORY CONTACT INFORMATION

**FACTORY NAME:** TRULY (HuiZhou) Smart Display Limited.

**FACTORY ADDRESS:** South N0.1, Xinhua Road, Chenjiang Town, Zhongkai High-Tech Zone, Huizhou, Guangdong.

**P.C:** 516029 **URL:** <http://www.truly.com.hk> <http://www.trulyhz.com>